

Mud Motor Bearing

PCDbearing-178

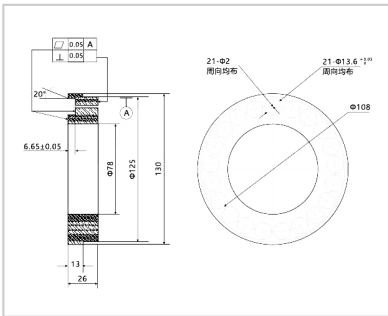

Model	PDC bearing 178×127
parent casing specifications	
OD (mm)	178
Wall thickness(mm)	11.51
ID(mm)	154.8
OD	
mm	146
Drift	
mm	100-124
Rated load	
kN	500-1500
Seal pressure	
MPa	≤30
Annularseal pressure	
MPa	≥25

Polycrystalline Diamond (PCD) radial bearings also named PCD Thrust bearing.

Diamond bearing PCD Thrust bearing are widely used for turbo drills and mud motors, we can supply the size from 1inch to 10inch in diameter with good quality and best price.

1.Product Introduction of PCD Thrust bearing

PCD Thrust Bearing is widely used in turbo drills, mud motors and other oil field applications. We have two different types includes PCD radial bearing and PCD thrust bearing. Compared with tungsten carbide bearing, The PCD bearing has longer working life, its life is 4-10 times longer than tungsten carbide bearing, meanwhile it can also bear the increased load capacity.

2.Product Specification of PCD Thrust bearing

The bearings are available in size from 1inch to 10inch in diameter.

We can make PCD Radial bearing and PCD Thrust bearing as your

specific drawings or samples.

3. Production Feature and Application of PCD Thrust bearing

High Hardness

High wear resistance

High corrosion resistance

Longer service life

widely used in turbo drills, mud motors and many other oil field applications.

Drilling motors (oil and gas)

Drilling turbines (oil and gas)

Other oil and gas drilling tools

There are four type configurations:

1. Thrust Polycrystalline Diamond (PCD) radial bearings

2. Tapered Polycrystalline Diamond (PCD) radial bearings

3. Radial Polycrystalline Diamond (PCD) radial bearings

4. Spherical Polycrystalline Diamond (PCD) radial bearings

The specifications $\varnothing 124 \times \varnothing 80 \times H26$ $\varnothing 148 \times \varnothing 91.5 \times H26$ PCD bearings have high resistance to grinding and can operate at high temperatures (currently at a maximum temperature of 233 ° C) and can withstand large axial loads. PCD materials have a low friction coefficient and are not affected by natural or mud chemicals present in the well. Each pair of PCD thrust bearings consists of an upper ring and a lower ring, and each bearing ring contains a cemented carbide ring and a PCD cutter.

Polycrystalline Diamond radial bearings are parts of PCD inserts assembled in carrier rings. PCD radial bearing set includes a rotating and stationary bearing ring. Two rings oppose each other with the PCD surface on the inside diameter of one ring in direct contact with the PCD surface on the outside diameter of the mating ring.

Allowed to provide PCD radial bearings that have accurate diameters,

tight clearance tolerances, and ultra-fine surface finishes.

The high hardness and strength PCD allow radial bearings to sustain highly loads during operation.

Otherwise, they bear at very low rate, resulting in the PCD bearings lasting from 900 hours to many years,

It's depending on the application. The PCD inserts also use highest quality steel. PCD bearings are very suitable for process-fluid-lubricated applications, especially where abrasive particles are present in the fluid. The PCD surfaces maintain their geometry and exhibit minimal wear in the presence of these abrasive-laden fluids.

Our PCD and TC (Tungsten carbide) Radial Bearing advantages are as the following:

- 1) Highly resistant to abrasion, erosion, corrosion, and mechanical failure.
- 2) Extremely resistant to chipping, cracking, and flaking which are inherent problems in cladding or welded overlay processes.
- 3) High heat conductivity eliminates thermal cracking.
- 4) Proprietary design eliminates catastrophic downhole radial bearing failure.
- 5) Carbide tile and matrix design ensures extended life compared to cladding or welded overlay designs.
- 6) Inner and outer components can be reconditioned.
- 7) The hardness of body surface can reach 30-37 HRC.

