

Harmonic Drive Bearing

CSF harmonic drive bearings-**CSF32-8022**

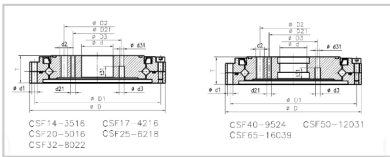

Bearing NO.	CSF32-8022
Dimensions (hli)	
d	26
D	112
T	22.5
D1	104
D2	55
D21	40
D3	34
n1-d1	16-φ4.5
n2-d2	8-M10
n21-d21	8-M8
n3-d3	4-φ5
d31	4-φ4.7
t31	10
rsmin	0.5 x 45 °
Basic Load ratings(KN)	
Cr	18.5
Cor	28.3
Weight	1.1

Product Description

Cross Roller Bearing for Harmonic Drive is cross roller structure. According to its application area there are two types (CSF/CSG Series and SHF/SHG Series). Rolling body are cylindrical rollers which arranged orthogonality, this structure can make one bearing can bear the load from every direction e.g. radial, axial and tilting torque etc. Bearing with high rigidity, rotation accuracy and load carrying capacity. This series bearing has compact appearance, with mounting hole, customer can mount directly, suitable for every kinds of harmonic drives.

CSF/CSG Series (Outer ring split, inner ring integrity)

Outer ring split, inner ring integrity structure, there is no need of flange and bearing seat. Suitable for every kind of CSF (CSG) series harmonic drives.

Classification Of Cross-Roller Bearings For Harmonic Drive

Harmonic speed reducers have the characteristics of small size, light

weight, high torque load, high rigidity, excellent positioning accuracy and rotation precision. Harmonic drive speed reducers' main components including wave generator, flex gear, ring gear, and cross roller bearing. The wave generator also contains thin raced ball bearing(flexible bearing).

According To The Different Structures, Harmonic Reducer Output Bearings Are Divided Into The Following Types

1. CSF|CSG harmonic drive gear units bearing (outer ring integral outer ring split type)
2. SHF series harmonic reducer cross roller bearing (inner and outer ring integrated type)
3. CSD series harmonic reducer cross roller bearing (inner and outer ring integrated type)

CSFseries crossed roller bearing is specially designed for CSF|CSG harmonic reducer. It has high dimensional precision and can provide excellent running accuracy, high loading capacity and good sealing effect. With multiple precision holes on the inner and outer ring, CSF|CSG harmonic drive gear units bearings can be connected with working parts directly.

Application

Harmonic reducer bearing has a wide range of application in electronics industry, industrial automation, industrial robots, packaging machines, printing machines, and medical equipments because of its high precision, high rigidity and high transmission ratio.

Lubrication

Bearing with high quality compound lithium-based grease in factory,so under normal using condition there is no need to add grease.but for bearing running ,in the inital stage ,the frictional torque will increase temporarily, frictional torque will be stable when grease uniformly adhere to raceway and roller.

- 1.Before installation, please clean bearing bracket, shaft, or other components, make sure there is no burrs or rough edge.
- 2.Install the locating pin to output bearing
- 3.Install the Screw 1, then install the Screw 2.

4. Install the wave generator and related components.

Mounting caution

WAVE GENERATOR COMPONENTS

- ① Ball Separator
- ② Wave Generator Bearing
- ③ Wave Generator Plug
- ④ Insert
- ⑤ Rub Washer
- ⑥ Snap Ring
- ⑦ Wave Generator Hub



Please clean up the parts e.g bearing seat ,axis etc,Which related to the bearing mounting. Check the burrs(make sure good fit tolerance between inner ring of bearing seat and outer ring of bearing, shaft neck and inner ring of bearing)

When tightening scw, Retaining bolt locking should be divided to 3~4 stages from incompleation locking to completion locking,according to the “ + crossing method” again and again.

Note

Please do not disassembly the bearing,for it is adjust by professional workers and to keep good preload and grease. If it runs abnormally after you receiving the bearing ,please contact us.Besides, bearing working temperature is -20~+80 Celsius ,if not ,pls contact us.

