

## Crossed Roller Bearing

### CRBT Super Slim Crossed Roller Bearings-50

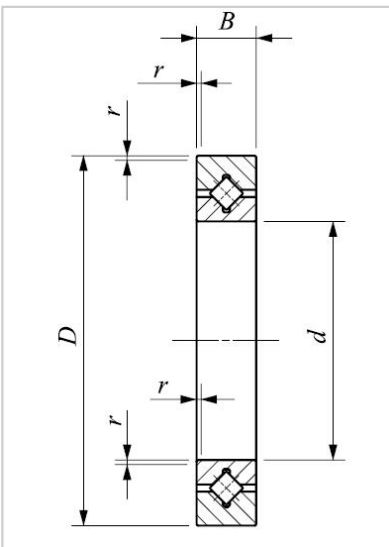
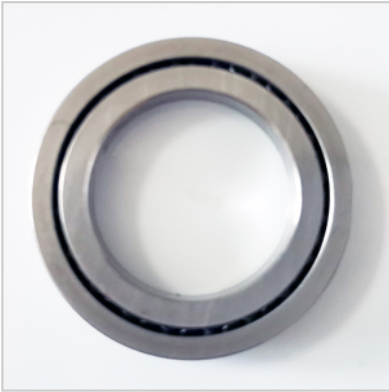

Mass (Ref.) g	<b>50</b>
Basic static load rating	
C0 [N]	CRBT505A
Basic dynamic load rating	
C [N]	<b>50</b>
Mounting dimensions (mm)	
Da	61
da	<b>5</b>
Boundary dimensions (mm)	
d	0.15
D	52.5
B	57
rmin	2280
Identification number	3200
Shaft dia. (mm)	32.3

### Features of Super Slim Type Crossed Roller Bearing CRBT

The world's thinnest roller type! Very low cross sectional height of **5.5 mm**.

The cross sectional height is reduced by 69% in comparison with CRBS, which was the thinnest before (bearing bore diameter 50 mm). The width is also as small as 5 mm and the cross sectional area is reduced by 43% in comparison with conventional products.

Significant weight saving by 38% in comparison with conventional types was realized. Weight reduction is thoroughly pursued. The mass ratio is 0.38 and significant weight saving was realized in comparison with conventional slim type CRBS (bearing bore diameter 50 mm).

## Structure and Features

### 1. Ultra-Slim and Ultra-Small!

These Crossed Roller Bearings are ultra-slim and small with a 10mm bearing bore, 21mm outside diameter, and 5mm bearing width.

### 2. High Rigidity and a Compact Size!

In Crossed Roller Bearings, the orthogonal array of rollers reduces the cross sectional area of rear-mounted 45° contact angle single-row roller bearings or ball bearings by half, creating a compact structure.

Even though they are more compact, the rigidity is 3 to 4 times greater than double-row angular contact ball bearings.

## ■ Comparison of bearing bore diameter 50 mm

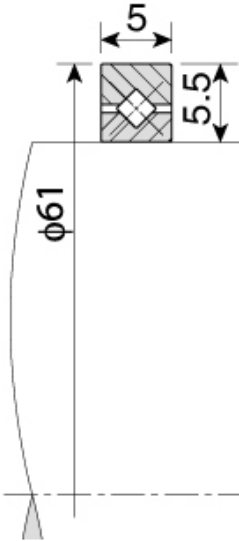
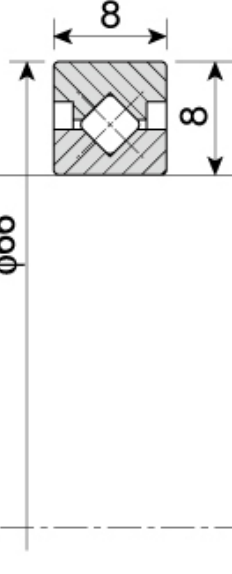
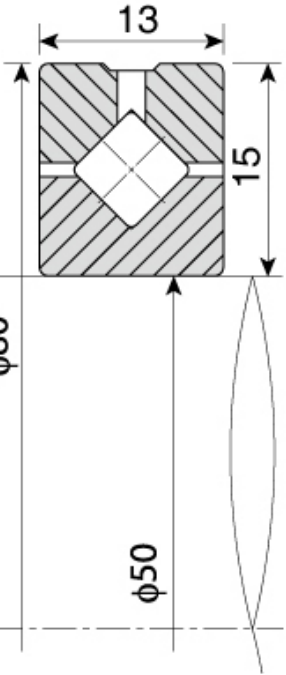
Sectional shape				
Item	Series	Super Slim CRBT505A	Slim CRBS508	High rigidity CRBH5013A
	Outer diameter mm	61	66	80
Width mm		5	8	13
Sectional height mm		5.5	8	15
$C$	N	2280	4900	17300
$C_0$	N	3200	6170	20900
Mass	g	32.3	84	290
	Compared with CRBH	0.11	0.29	1.00
	Compared with CRBS	0.38	1.00	3.45

### What are Crossed Roller Bearings?

Crossed Roller Bearings are compact bearings with their rollers alternately crossed at right angles to each other between inner

and outer rings. The orthogonal array of the rollers allows the bearing to handle complex loads simultaneously from any direction, which makes assembly possible without needing to worry about load direction.

## Compact Hand Robot

Crossed Roller Bearings feature high rotational accuracy and high rigidity which minimizes deflection, making them ideal for the

swivel parts of hand robots, that require accurate positioning motion.

## Compact Surveillance Camera

Crossed Roller Bearings can receive complex loads from various directions, making them ideal bearings for supporting surveillance

cameras which are in constant 24-hour operation.

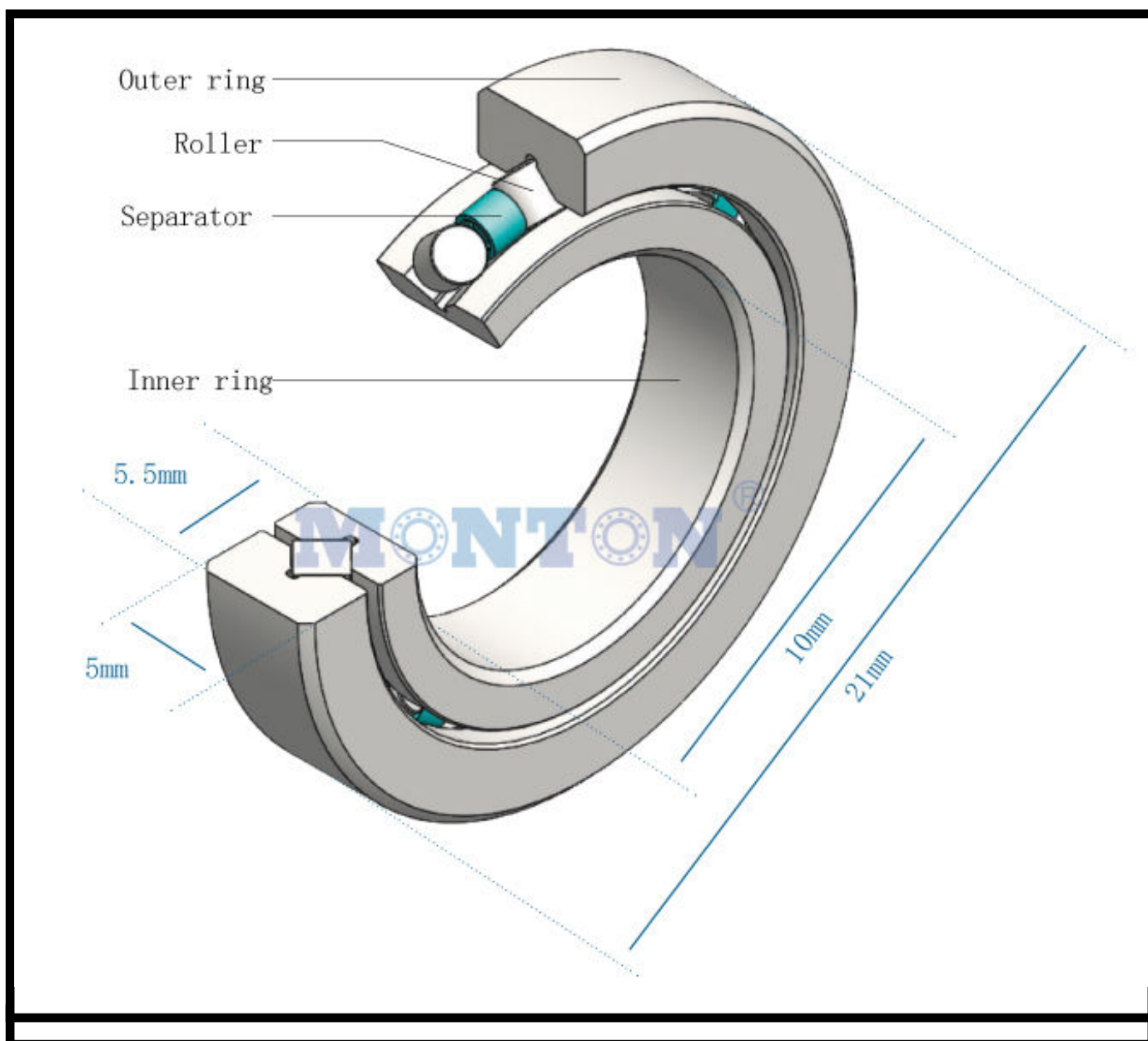

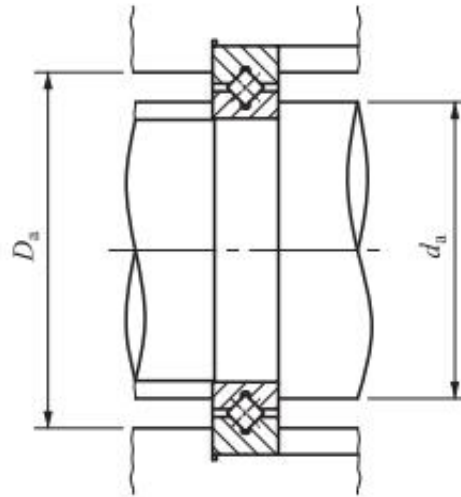
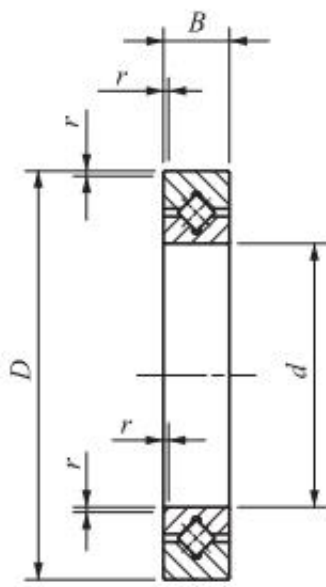

CRBT...A

Shaft dia. mm	Identification number	Boundary dimensions (mm)				dimensions (mm)		Basic dynamic load rating C	Basic static load rating C0	Mass (Ref.) g
		d	D	B	r <sub>min</sub>	da	Da	N	N	
10	CRBT105A	10	21	5	0.15	12.5	17	1120	811	9
15	CRBT155A	15	26	5	0.15	17.5	22	1320	1110	11.9
20	CRBT205A	20	31	5	0.15	22.5	27	1400	1290	14.8
30	CRBT305A	30	41	5	0.15	32.5	37	1770	1970	20.7
40	CRBT405A	40	51	5	0.15	42.5	47	2200	2520	26.5
50	CRBT505A	50	61	5	0.15	52.5	57	2280	3200	32.3
60	CRBT605A	60	71	5	0.15	62.5	67	2.63	4.09	38
70	CRBT705A	70	81	5	0.15	72.5	77	2.81	4.68	44
80	CRBT805A	80	91	5	0.15	82.5	87	3.05	5.43	50