

ZKLF ZKLN Double Direction Axial Angular Contact Ball Bearings

ZKLN Axial angular contact ball bearings-**ZKLN90150-2Z**

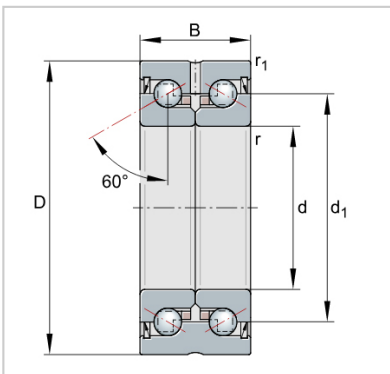

Designation	ZKLN90150-2Z
Mass m = kg	4.5
Dimensions	
d	90
D -0,010	150
B -0,25	55
d1	120
r min.	0.6
r1 min.	0.6
Mounting dimensions	
Da max.	138
da min.	116
Basic load ratings axial	
dyn. Ca N	149000
stat. C0a N	395000
Fatigue limit load Cu N	21300
Lim- iting speed nG	3500
grease min-1	
Thermally safe	2300
operating speed nP	
min-1	
Bearing frictional torque	2.3
MR Nm	
Rigidity axial caL N/μm	1700
Tilting rigidity ckL	4400
Nm/mrad	
Mass moment of	59.9
inertia1) Mm kg · cm ²	
Axial runout1) μm	3
Recommended INA precision locknut2)	
For radial locking	ZMA90/130
Tightening torque4) MA AM90	
Nm	
Tightening torque4) MA 200	
Nm	
Required locknut	22731
force3) axial N	