

ZKLF ZKLN Double Direction Axial Angular Contact Ball Bearings

ZKLN Axial angular contact ball bearings-ZKLN0624-2RS-PE

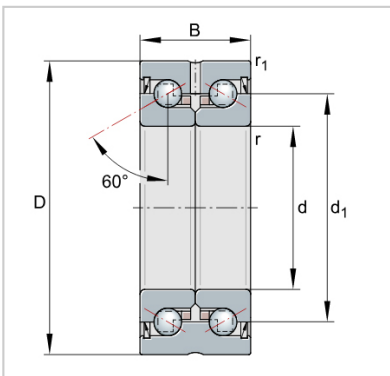

Designation	ZKLN0624-2RS-PE
Mass m = kg	0.03
Dimensions	
d	6
D -0,010	24
B -0,25	15
d1	14
r min.	0.3
r1 min.	0.6
Mounting dimensions	
Da max.	19
da min.	9
Basic load ratings axial	
dyn. Ca N	6900
stat. C0a N	8500
Fatigue limit load Cu N	375
Lim- iting speed nG	16400
grease min-1	
Thermally safe	6800
operating speed nP	
min-1	
Bearing frictional torque	0.04
MR Nm	
Rigidity axial caL N/μm	200
Tilting rigidity ckL	8
Nm/mrad	
Mass moment of	0.0044
inertia1) Mm kg · cm ²	
Axial runout1) μm	5
Recommended INA precision locknut2)	
For radial locking	ZM06
Tightening torque4) MA -	
Nm	
Tightening torque4) MA 2	
Nm	
Required locknut	2404
force3) axial N	