

Ultra High-Speed Angular Contact Ball Bearings

BNR Series Ultra High-Speed Angular Contact Ball Bearings-40BNR19H

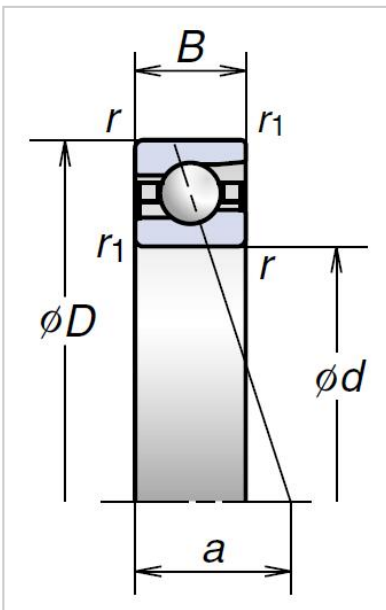

Bearing NO.	40BNR19H
Boundary Dimensions (mm)	
d	40
D	62
B	12
r (min.)	0.6
r1 (min.)	0.3
Basic Load Ratings (kN)	
Cr (Dynamic)	11.5
C0r (Static)	7.65
Permissible Axial Load (1) (kN)	7.1
Effective Load Center (mm) a	14.3
Sealed Design	
Limiting Speeds (2) (min ⁻¹)	
Grease	35300
Oil	55000
Mass (kg)	0.092