

Ultra High-Speed Angular Contact Ball Bearings

BGR Series Ultra High-Speed Angular Contact Ball Bearings-7BGR10S

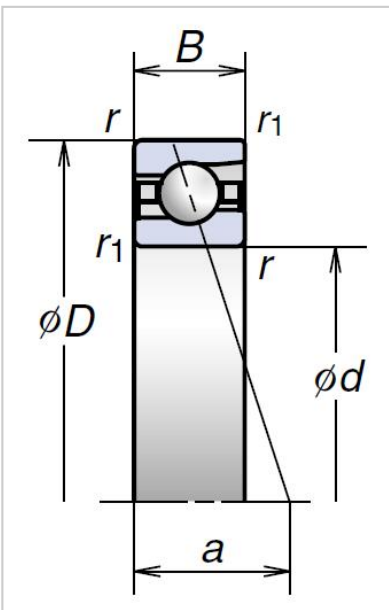

Bearing NO.	7BGR10S
Dimensions	
D (mm)	7
d (mm)	19
2B (mm)	6
r Min	0.3
r1 Min	0.15
Basic Loading Ratings(KN)	
Cr (Dynamic)	1.6
C0r (Static)	0.52
Permissible axial load (KN)	0.62
Effective load center(mm) a	4.7
Limiting speeds [rpm]min-1	
Grease	124000
Oil	170000
Weight (kg)	0.008