

## Ultra High-Speed Angular Contact Ball Bearings

### BGR Series Ultra High-Speed Angular Contact Ball Bearings-6BGR10S

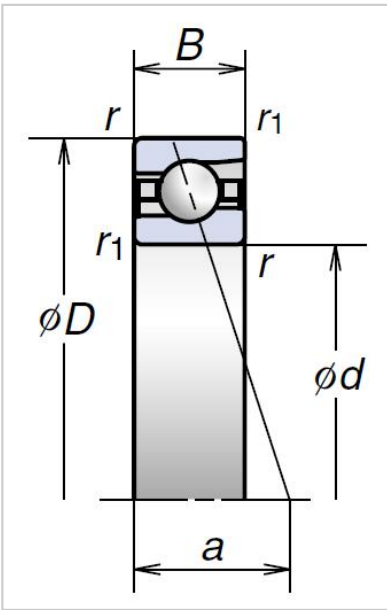

Bearing NO.	<b>6BGR10S</b>
Dimensions	
D (mm)	<b>6</b>
d (mm)	17
2B (mm)	<b>6</b>
r Min	0.3
r1 Min	0.15
Basic Loading Ratings(KN)	
Cr (Dynamic)	1.42
C0r (Static)	0.43
Permissible axial load (KN)	0.51
Effective load center(mm) a	4.5
Limiting speeds [rpm]min-1	
Grease	140000
Oil	192000
Weight (kg)	0.006