

Ultra High-Speed Angular Contact Ball Bearings

BGR Series Ultra High-Speed Angular Contact Ball Bearings-25BGR10H

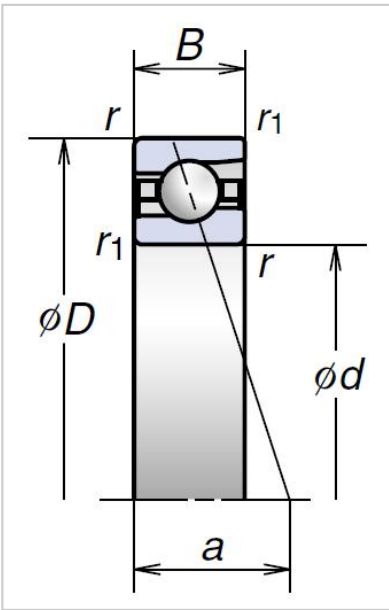

Bearing NO.	25BGR10H
Dimensions	
D (mm)	25
d (mm)	47
2B (mm)	12
r Min	0.6
r1 Min	0.3
Basic Loading Ratings(KN)	
Cr (Dynamic)	7.9
C0r (Static)	3.75
Permissible axial load (KN)	3.05
Effective load center(mm) a	10.8
Limiting speeds [rpm][min-1]	
Grease	52800
Oil	77800
Weight (kg)	0.068