

Ultra High-Speed Angular Contact Ball Bearings

BGR Series Ultra High-Speed Angular Contact Ball Bearings-20BGR10S

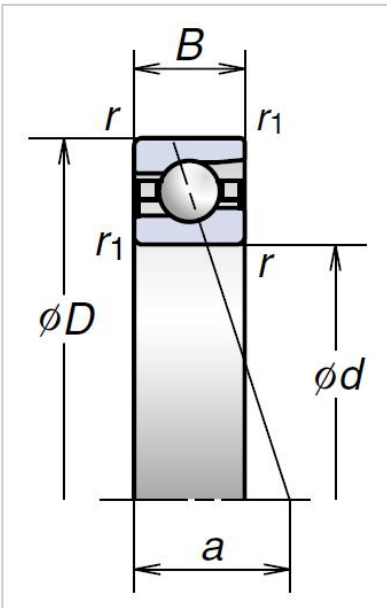

Bearing NO.	20BGR10S
Dimensions	
D (mm)	20
d (mm)	42
2B (mm)	12
r Min	0.6
r1 Min	0.3
Basic Loading Ratings(KN)	
Cr (Dynamic)	7.45
C0r (Static)	3.35
Permissible axial load (KN)	4.1
Effective load center(mm) a	10.2
Limiting speeds [rpm][min-1]	
Grease	51700
Oil	71000
Weight (kg)	0.066