

Ultra High-Speed Angular Contact Ball Bearings

BGR Series Ultra High-Speed Angular Contact Ball Bearings-17BGR19S

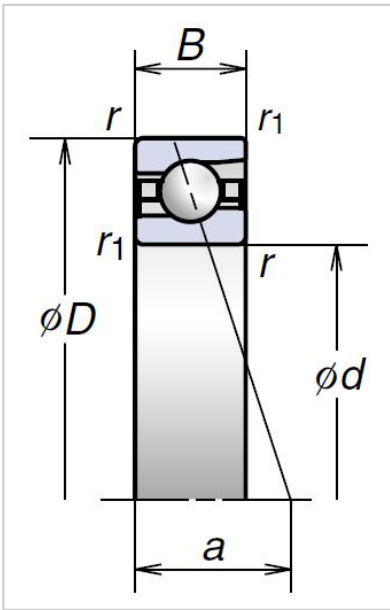

Bearing NO.	17BGR19S
Dimensions	
D (mm)	17
d (mm)	30
2B (mm)	7
r Min	0.3
r1 Min	0.15
Basic Loading Ratings(KN)	
Cr (Dynamic)	3.4
C0r (Static)	1.5
Permissible axial load (KN)	1.86
Effective load center(mm) a	6.6
Limiting speeds [rpm][min-1]	
Grease	68100
Oil	93700
Weight (kg)	0.017