

Ultra High-Speed Angular Contact Ball Bearings

BGR Series Ultra High-Speed Angular Contact Ball Bearings-15BGR10S

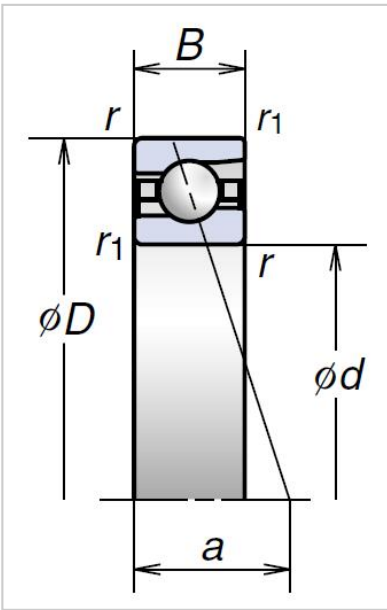

Bearing NO.	15BGR10S
Dimensions	
D (mm)	15
d (mm)	32
2B (mm)	9
r Min	0.3
r1 Min	0.15
Basic Loading Ratings(KN)	
Cr (Dynamic)	4.2
C0r (Static)	1.72
Permissible axial load (KN)	2.12
Effective load center(mm) a	7.6
Limiting speeds [rpm]min-1	
Grease	68100
Oil	93700
Weight (kg)	0.029