

Ultra High-Speed Angular Contact Ball Bearings

BGR Series Ultra High-Speed Angular Contact Ball Bearings-12BGR10X

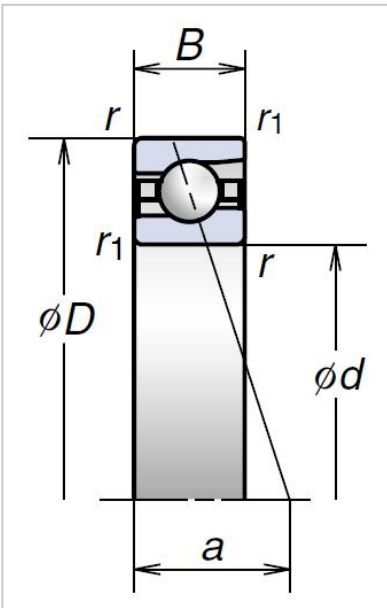

Bearing NO.	12BGR10X
Dimensions	
D (mm)	12
d (mm)	28
2B (mm)	8
r Min	0.3
r1 Min	0.15
Basic Loading Ratings(KN)	
Cr (Dynamic)	3.85
C0r (Static)	1.48
Permissible axial load (KN)	1.17
Effective load center(mm) a	6.7
Limiting speeds [rpm][min-1]	
Grease	110000
Oil	150000
Weight (kg)	0.018