

Ultra High-Speed Angular Contact Ball Bearings

BGR Series Ultra High-Speed Angular Contact Ball Bearings-12BGR10S

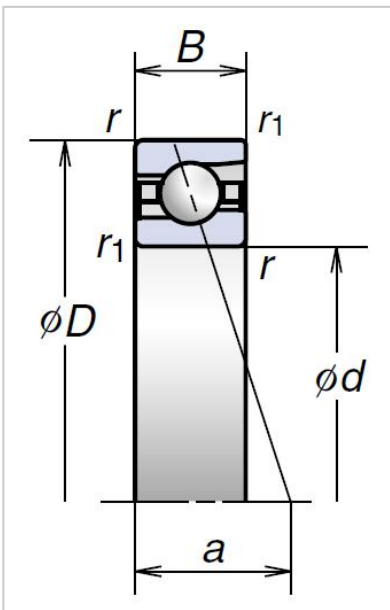

Bearing NO.	12BGR10S
Dimensions	
D (mm)	12
d (mm)	28
2B (mm)	8
r Min	0.3
r1 Min	0.15
Basic Loading Ratings(KN)	
Cr (Dynamic)	3.85
C0r (Static)	1.48
Permissible axial load (KN)	1.8
Effective load center(mm) a	6.7
Limiting speeds [rpm]min-1	
Grease	80000
Oil	110000
Weight (kg)	0.021