

Angular Contact Ball Bearing

B70XX Light Series Angular Contact Ball Bearings-**B7007-E-T-P4S**

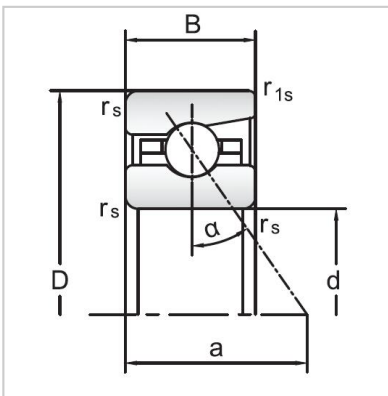
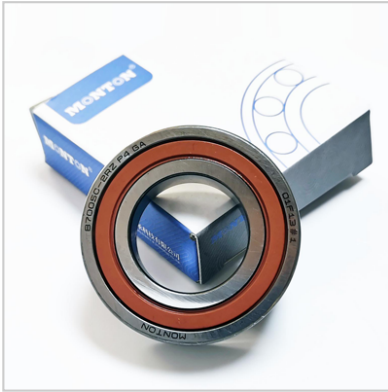

Designation	B7007-E-T-P4S
Dimensions	
d	35
D	62
B	14
Basic loading	
Dynamic Cr KN	18.3
Static Cor KN	12.9
Weight	
KG	22000
Limiting Speed	
nG Oil	34000
nG Greas	0.15

MONTON B70XX light series angular contact ball bearings are inseparable design, produce size range inner diameters from

6 to 360mm. The bearings have a variety of designs and structure, we can provide to customer with wide range choices, so that

each machine tool spindle can match one suitable precision bearings. MONTON provides contact angles of 15°, 18°, 25°, 30°

and 40°. The contact angle of the bearing increases, the axial load capacity increases. At the same time, MONTON can also

provide high load, high rigidity and high speed bearings. The rolling elements include steel balls and hybrid ceramic balls for

customers to choose. There are open and sealed bearings which can provide best support for customers.

MONTON B70XX light series is mainly suitable for applications with large space and not too heavy load. MONTON provide

customer with different products and combinations according to working conditions.
MONTON can provide customers with

products of different precision levels of P5, P4, and P2. Our hybrid ceramic ball bearings use silicon nitride Si₃N₄ ceramic

balls, which have higher stiffness, higher speed, low friction, low loss, longer bearing lubrication service life, higher precision,

and reduce the outer ring rolling contact stress at high speed. Universal matching bearings with the same bearing inner diameter

deviation and the same bearing outer diameter deviation, a single bearing can be installed in any bearing arrangement

requirements.

MONTON's bearing designs :

1. Single installation U (universal) or assembled in group ad D (Double) T (Triple) Q (Quater), etc.
2. Universal bearings or universal bearing sets
3. Bearings using steel balls or hybrid ceramic ball bearings
4. Open type or bearings with seals on both sides
5. Bearings directly lubricated through the circumferential lubrication grooves and radial lubrication holes on the outer ring of the bearing
6. Preload is divided into three types: light L, medium M, and heavy H

Main applications include:

1. Machining center (horizontal or vertical)
2. High speed milling machine
3. Lathe
4. External cylindrical and surface grinders
5. Boring machine
6. Cutting Machine tools for cutting or polishing stone and glass
7. Semiconductor industry, etc., fault detection units on silicon wafers
8. Marine gyro stabilizers
9. Telescopes

10. Gas turbine engines
11. Racing/supercar wheels
12. Medical equipment
13. Electric spindles
14. Spindle for PCB drilling
15. Woodworking machine tools

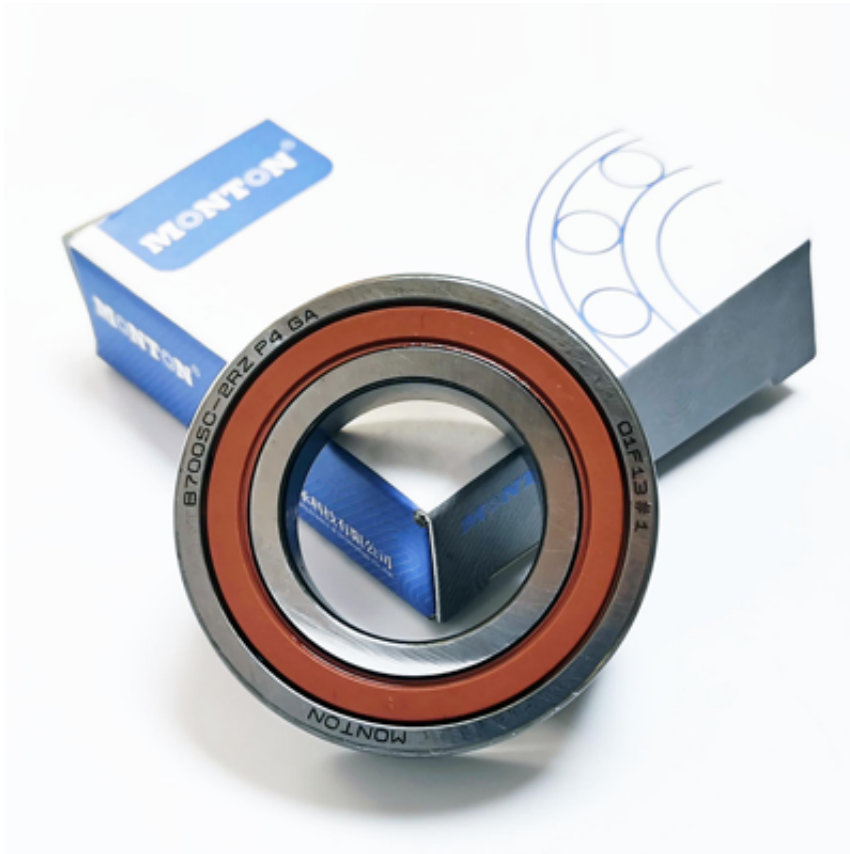

Our company has professional sales and technical engineers who are responsible for providing users with technical consultation,

technical services and product technical training on precision bearing information and installation and application. Perfect

pre-sales, in-sales and after-sales services constitute a guarantee system for high-quality services, providing users with reliable

quality bearing products, and creating excellent user experience and rich benefits for every user.

If you have any questions about products and services, please contact the company's service department directly.