

Angular Contact Ball Bearings

Double direction angular contact ball bearing-234738M

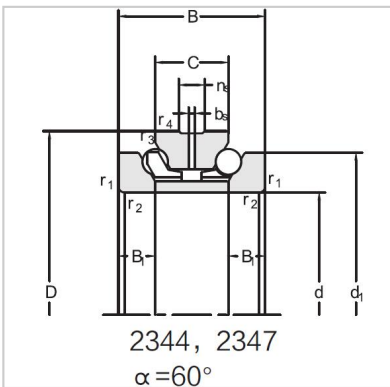

Bearing NO.	234738M
Dimension(mm)	
d	197
D	290
d1	258
T	120
C	60
B	30
rsmin	2.1
r1smin	0.6
Assembly Demension	
da	231
Da	273
ra	2.1
rb	0.6
Loading(KN)	
Ca	224
Coa	630
RPM(r/min)	
Lub.	1900
Oil	2800
Oil groove and oil hole(mm)	
n	15
k	8
Stiffness(N/ μ m)	
Ra	1495
Weight(Kg)	
\approx	22.6