

Angular Contact Ball Bearings

Double direction angular contact ball bearing-234724M

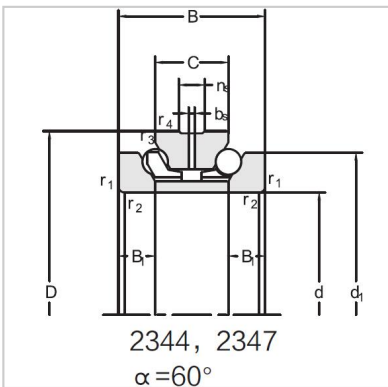

Bearing NO.	234724M
Dimension(mm)	
d	124
D	130
d1	160
T	72
C	36
B	18
rsmin	2
r1smin	0.6
Assembly Demension	
da	144.5
Da	170
ra	2
rb	0.6
Loading(KN)	
Ca	93
Coa	240
RPM(r/min)	
Lub.	3200
Oil	4300
Oil groove and oil hole(mm)	
n	9.5
k	4.8
Stiffness(N/μm)	
Ra	996
Weight(Kg)	
≈	5.14