

Angular Contact Ball Bearings

Double direction angular contact ball bearing-234720M

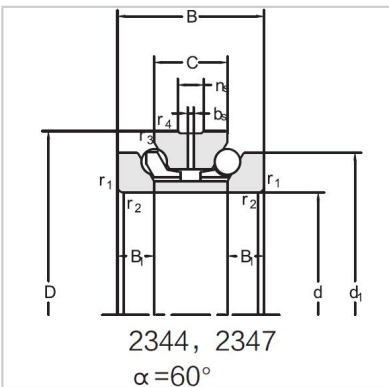

Bearing NO.	234720M
Dimension(mm)	
d	103
D	150
d1	133
T	60
C	30
B	15
rsmin	1.5
r1smin	0.3
Assembly Demension	
da	120.5
Da	140.5
ra	1.5
rb	0.3
Loading(KN)	
Ca	62
Coa	156
RPM(r/min)	
Lub.	3800
Oil	5000
Oil groove and oil hole(mm)	
n	9.5
k	4.8
Stiffness(N/μm)	
Ra	843
Weight(Kg)	
≈	2.95