

Angular Contact Ball Bearings

Double direction angular contact ball bearing-234719M

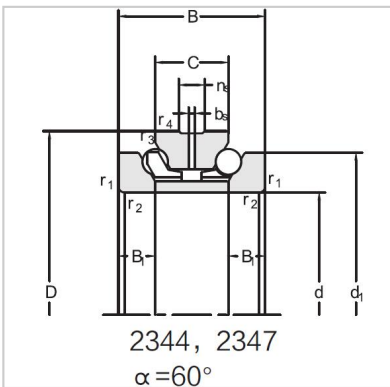

Bearing NO.	234719M
Dimension(mm)	
d	98
D	145
d1	128
T	60
C	30
B	15
rsmin	1.5
r1smin	0.3
Assembly Demension	
da	115.5
Da	135.5
ra	1.5
rb	0.3
Loading(KN)	
Ca	61
Coa	150
RPM(r/min)	
Lub.	4000
Oil	5300
Oil groove and oil hole(mm)	
n	9.5
k	4.8
Stiffness(N/μm)	
Ra	724
Weight(Kg)	
≈	2.83