

Angular Contact Ball Bearings

Double direction angular contact ball bearing-234712M

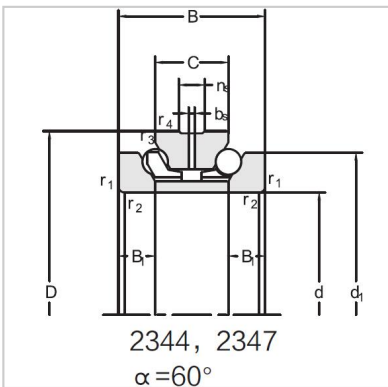

Bearing NO.	234712M
Dimension(mm)	
d	62
D	95
d1	83
T	44
C	22
B	11
rsmin	1.1
r1smin	0.3
Assembly Demension	
da	74
Da	89.5
ra	1
rb	0.3
Loading(KN)	
Ca	33.5
Coa	68
RPM(r/min)	
Lub.	6000
Oil	8000
Oil groove and oil hole(mm)	
n	6.5
k	3.2
Stiffness(N/ μ m)	
Ra	455
Weight(Kg)	
\approx	0.94