

Angular Contact Ball Bearings

BS/TAC Series Ball Screw Support Angular Contact Ball Bearings-BS55100

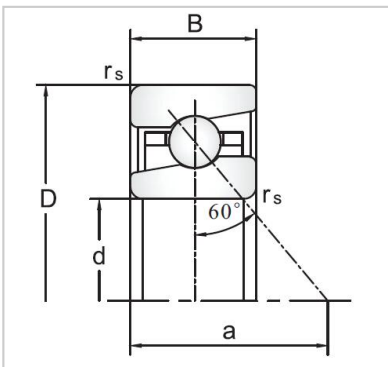
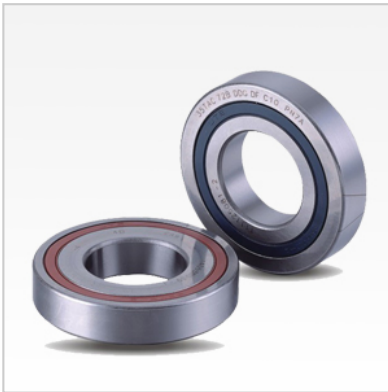

Bearing NO.

BS **BS55100**

TAC 55TAC100C

Dimensions(mm)

d **55**

D **100**

B 20

r Min **1**

r1 Max 0.6

Load Ca (N) 66

Rotation [min-1]

Lub. 3000

Oil. 3900

Stiffness (DB,DF) (N) H 4650

Rigidity (DB,DF) (N/μm) 1410

H

Torque (N[m] H) 0.42

Weight (kg) 0.714