

MONTON

挤出机串联推力轴承
Tandem Bearings for Extruder Gearbox



MONTON

LUOYANG MONTON BEARING SCIENCE & TECHNOLOGY CO.,LTD.
No.68 Letian Road,Luoyang,Henan,China 471039
Tel:+86 13213639372
Whatsapp:+86 13213639372
Email:sales@montonbearings.com
www.montonbearings.com
www.montonbearing.com

洛阳盟拓轴承科技有限公司

LUOYANG MONTON BEARING SCIENCE & TECHNOLOGY CO.,LTD.

公司简介

COMPANY PROFILE

盟拓轴承成立于2001年，坐落于“千年古都、牡丹花城”洛阳，我们专注轴承领域20多年，专注于“高新科技、精密、先进、非标”轴承的研发，是一家高新技术企业。公司占地面积35000平方米，建筑面积20000平方米，其中办公区域占地面积3000平米，研发中心占地面积500平米，国际营销会议接待中心 2000平方米。盟拓轴承的使命是一直并将继续为客户提供完整的集成解决方案，其中包括设计与开发制造测试与评估以及完善的售后服务。工厂位于河南省洛阳市宜阳县产业集聚区轴承产业园内。

MONTON bearing a main manufacturers leader of high precision bearings in China was established in 2001 locate in Luoyang--“Ancient Imperial Capital and Peony Flower City”,we specialized in the bearing production research and development more than 20 years , focus on the development of "High-tech, High precision, Advancing, customized" bearings development .MONTON covers an area of of 35000 sq.m., building area of 20000 sq.m., including office area 3000 sq.m., research and development center of 500 sq.m., and international marketing & reception center 2000sq.m.Our mission is to provide customers with complete solution, including design and development, manufacturing, testing and evaluation, and excellent after-sales service.The factory is located in the Bearing Industry Park of Yiyang County, Luoyang City, Henan Province.

盟拓轴承主要生产角接触球轴承、丝杠轴承、超低温轴承、高速电机轴承、特种精密轴承、交叉滚子轴承、谐波减速机轴承、推力轴承组、TC向心轴承、等截面薄壁轴承、串列推力圆柱滚子轴承、非标定制轴承及轴承组件。产品精度可达到P5/P4/P2级；滚动体产品可生产 ϕ 1mm至160mm，精度等级为 I、II级。为河南科技大学、大连理工、哈尔滨工大、北京科技、北京交通、中国石油等多所知名院校的重要科研项目做出突出贡献。

MONTON bearing mainly produce high precision angular contact ball bearing, ball screw support bearing,Low temperature bearing,High speed motor bearings, military thin section ball bearing,special high precision bearing, crossed roller bearing,harmonic drive bearing,thrust bearing stack,Tungsten Carbide Radial Bearing, military thin section ball bearing,tandem bearing,cylindrical roller bearing, customized bearing and bearings parts, The bearing accuracy at P5/P4/P2 level, rolling elements from ϕ 1mm to 160mm, precision degree I,II.We Contributions to important scientific research projects of several well-known universities, including Henan University of Science and Technology, Dalian University of Technology, Harbin Institute of Technology, Beijing University of Science and Technology, Beijing traffic University, and China Petroleum etc.

我们生产内径1.5mm至外径3m的轴承和部件。我们的产品已广泛应用于数控机床、高速主轴、精密仪器、石油钻井、石油化工、低温泵、高速电机、矿山冶金、港口机械、齿轮箱、水泥、纺织、钢厂轧机、连铸机、造纸机械、混凝土搅拌车、钢厂连铸轧机、风力发电、工业机器人、谐波减速机、协作机器人、航空航天等重要工业领域。

We produce bearings and parts with inner diameter of 1.5mm to an outer diameter of 3000mm. Our products have been widely used in important industrial fields such as CNC machine tools, high-speed spindles, precision measurement instruments, oil drilling, petrochemicals,Cryogenic pump, FANUC/Siemens motors, mining metallurgy, port machinery, medical equipment, extruder gearbox, Cement roller press, vertical mill, rocker arm, textiles equipment, paper mill,robotics, harmonic drive, concrete mixer trucks, steel mills, rolling mills,Wind Power,Continuous casting mill, UAV, Air Compressor,Tension levelers,LIDAR systems,missile tracking camera ,aerospace, etc.

我司拥有良好的生产保障条件，关键生产设备及检测仪器均为国外进口设备或公司自主改造的专用设备;主要检测仪器采用日本ACCRETECH、泰勒，德国Zeiss等进口品牌;建有精密轴承产品试验室，能够开展产品性能及寿命试验;通过ISO9001质量体系认证;具备年产各类精密轴承100万套的生产能力。

Our company have very good products quality guarantee equipment, key equipment and instrumentation are imported or design special equipment for special procedure by us. Main instrumentation is Japan ACCRETECH, TAYLOR,ZEISS Germany etc. Established precision bearing product testing laboratory, we can test bearing performance and life,Passed ISO9001 quality system certification, with an annual production capacity of 1 million sets of various precision bearings.

公司拥有各种数控车床、加工中心、数控磨床、超精设备160余台。数控车床10台，数控精密磨床65台，4轴加工中心一台。超声波清洗线和输送带2条，回火稳定炉2台，热处理炉1台，低温稳定设备1台，真空设备1台，自动装配线8条。检测设备有日本三丰轮廓仪,圆度仪,硬度仪,三坐标,测长仪,振动测量仪,接触角测量仪,凸出量测量仪,硬度计,金相测量仪,游隙测量仪,高度测量仪,内外径以及旋转精度测量仪等。

MONTON owns CNC lathes, machining centers, CNC grinding machines, and ultra precision equipment more than 160 sets. 10 CNC lathes, 65 CNC precision grinding machines, and 1set 4-axis machining center. 2 sets Ultrasonic cleaning line and equipment,2 sets tempering and stabilizing furnaces,1set heat treatment furnace, 1sets low temperature stabilization equipment and vacuum equipment,8 production lines of automatic assembly.Inspection equipment include Mitotoyo Japan Contour,roundness measuring instrument,hardness tester,coordinate measuring instrument, length measuring instrument,vibration measuring instrument,contact angle goniometer,Bearing convexity value measuring instrument,hardness tester,Metallographic tissue measuring instrument,Clearance measuring instrument,height measuring instrument,Inner diameter outer diameter and rotation accuracy measuring instrument etc.

公司现有员工140余名，其中，技术人员10人，检验人员25人。现有硕士学位以上人员5名，本科学历25名，专科学历人员30名。

We have more than 140 employees, including 10 technical persons and 25 inspection persons. There are 5 persons with a master's degree, 25 persons with bachelor's degree, and 30 with vocational degree currently .

我们具有创新精神，有动力和勇气为我们的客户提供必要的解决方案，我们的管理层和员工随时准备提供专业和为我们的客户提供个性化服务。盟拓未来将坚持品牌发展战略，加强高端产品的研发，努力打造数字化工厂，携手更多的合作伙伴，同心经营，共创美好未来！

We are innovative, motivated and courageous to provide our customers with necessary solutions. Our management and employees are always ready to provide professional and personalized services to our customers. In the future, MONTON will adhere to the brand development strategy, strengthen the research and development of high-end products, strive to build a digital factory, and join hands with more partners to work together for a better future!

目录 Catalogue

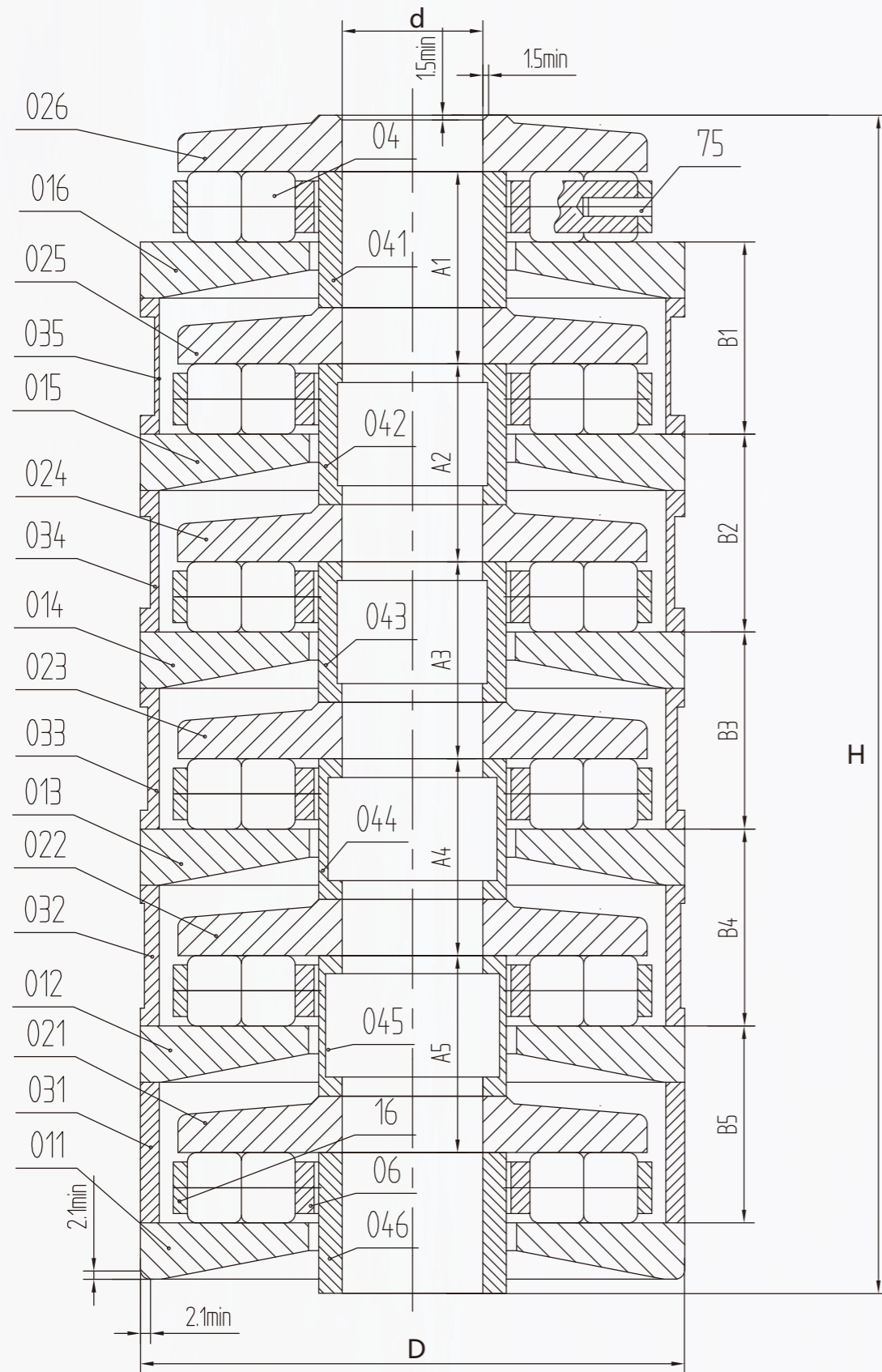

挤出机轴承零件示意图
Tandem bearing drawing and parts number

- 01 ■ 产品介绍
Introduction
- 02 ■ 应用
Application
- 03 ■ 设计要求
Design Terms
- 04 ■ 负载
Loading
- 05 ■ 润滑
Lubrication
- 06 ■ 轴承布置
Arrangement
- 07 ■ 选型表
Product Table
- 08 ■ 产品图片
Pictures
- 09 ■ 公司能力
Ability

产品介绍 Introduce

我公司开生产的串列推力圆柱滚子轴承具有径向截面尺寸小，结构紧凑，载荷能力大，每列滚子载荷均匀，耐磨，振动噪声小和寿命长等特点，是平行螺杆挤出机的理想主轴轴承。串列轴承有两列、三列、四列、五列、六列和八列之分，可根据螺杆中心距、空间大小和负荷大小任意选择。

Multi-stage cylindrical roller bearings (Tandem bearings) has the characteristics of limited radial space, high axial forces, equal support of all the rows of rollers and long operating life, and is the ideal spindle of parallel screw extruder. The tandem bearings provided by our institute has the following types: double rows, three rows, four rows, five rows, six rows and eight rows, we also provided bearings with shaft and sleeve barrel. Customers can have their own selections according to center distance of screws, space and load. We also accept the orders of other dimensions.

设计代号 Designation

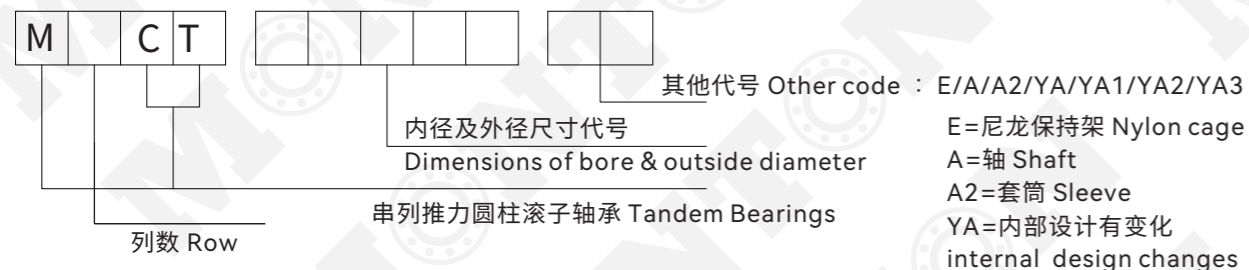

示例:

- M4CT2264 四列串列轴承，内径22mm，外径64mm；
- M4CT2264A 带轴型四列串列轴承，内径22mm，外径64mm,带轴；
- M6CT2390A2 套筒型六列串列轴承，内径23mm，外径90mm 带套筒。

Example:

- M4CT2264 Tandem Bearing, ID 22mm,OD 64mm;
- M4CT2264A Tandem Bearing with shaft, ID 22mm,OD 64mm, With shaft;
- M6CT2390A2 Tandem Bearing with shaft, ID 23mm · OD 90mm with sleeve.

应用 Application

使用串列轴承，应遵守下列要求：

- 预负荷：加1%轴承基本额定动负荷，每种串列轴承的基本额定动负荷，见后表，表中未列出的负荷，由本公司提供。
- 径向引导：可以用满装圆柱滚子轴承或滚针轴承。
- 消除倾斜：支承部件在机械加工中，必须消除任何倾斜，即支承面的倾斜度。
- 配合公差：为保证正确运行，我所推荐配合公差：轴f6，座孔F7。
- 轴承润滑：串列轴承必须经常使用稀油润滑，润滑油流如图：

When using MONTON tandem bearings, the following recommendations should be adhered to:

- Preloading: 1% of the dynamic basic load rating. The dynamic basic load rating of each tandem bearing see Figure 1~3. Figures not listed will be provided by out institute on request.
- Radial guidance: full complement cylindrical roller bearings or needle roller bearings can be used.
- Eliminate tilting: the supporting parts must be machined to eliminate any tilting.
- Mounting tolerances: MONTON recommended the following mounting tolerances: shaft f6 and housing bore F7.
- Lubrication: tandem bearings must always be lubricated by oil circulation (Figure below)

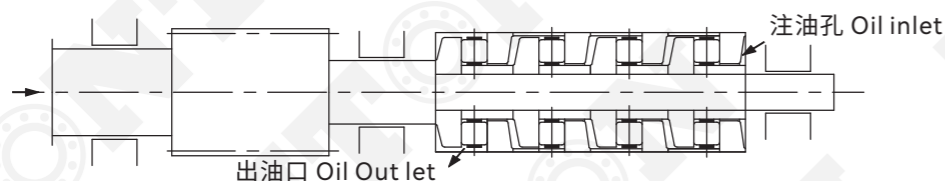

串列轴承润滑油流示意图
(Fig of Tandem bearings lubricating system)

应用案例 Application examples:

由于串列推力圆柱滚子轴承具有有限的径向截面，超级的轴向承载能力，长期的工作寿命和最小的摩擦损耗，所以在橡塑工业中的单、平行双螺杆挤出机齿轮传动箱中得到极为成功的应用。也将在深孔钻机和摩擦钎焊机机械得到广泛应用。下图为四列推力圆柱滚子轴承的应用示意图：

1. 推力圆柱滚子轴承 81100 系列配合 轴h6 壳H7
- 2&5. 单列满装圆柱滚子轴承 SL1822……C3 系列配合 轴p6 壳H7
3. 单列满装圆柱滚子轴承 SL1830……C3 系列配合 轴p6 壳H7
4. 三列满装圆柱滚子轴承 SL139…… 系列配合 轴m6 壳H7
6. 四列串列推力圆柱滚子轴承 T4AR…… 系列配合 轴f6 壳F7
7. 双列满装圆柱滚子轴承 SL1850……C3 系列配合 轴p6 壳H7
8. 单列满装圆柱滚子轴承 SL1829……C3 系列配合 轴p6 壳H7
9. 推力圆柱滚子轴承 89400 系列配合 轴h6 壳H7
10. 圆锥滚子轴承 31300 系列配合 轴h6 壳H7

The tandem bearings has been successfully used in gear boxes for single and twin screw extruders in the rubber and plastics industries due to its limited radial space, high axial forces, long operating life and low frictional power.

Figure of an application example of tandem bearings 4-row in twin screw extruder.

1. Axial cylindrical roller bearings shaft h6 housing H7
- 2&5. Single-row full complement cylindrical roller bearings shaft p6 housing H7
3. Single-row full complement cylindrical roller bearings shaft p6 housing H7
4. 3-row full complement cylindrical roller bearings shaft m6 housing H7
6. 4-row tandem bearings shaft f6 housing H7
7. Double-row full complement cylindrical roller bearings shaft m6 housing H7
9. Axial cylindrical roller bearings shaft h6 housing H7
10. Tapered roller bearings 31300 match with shaft h6 housing H7

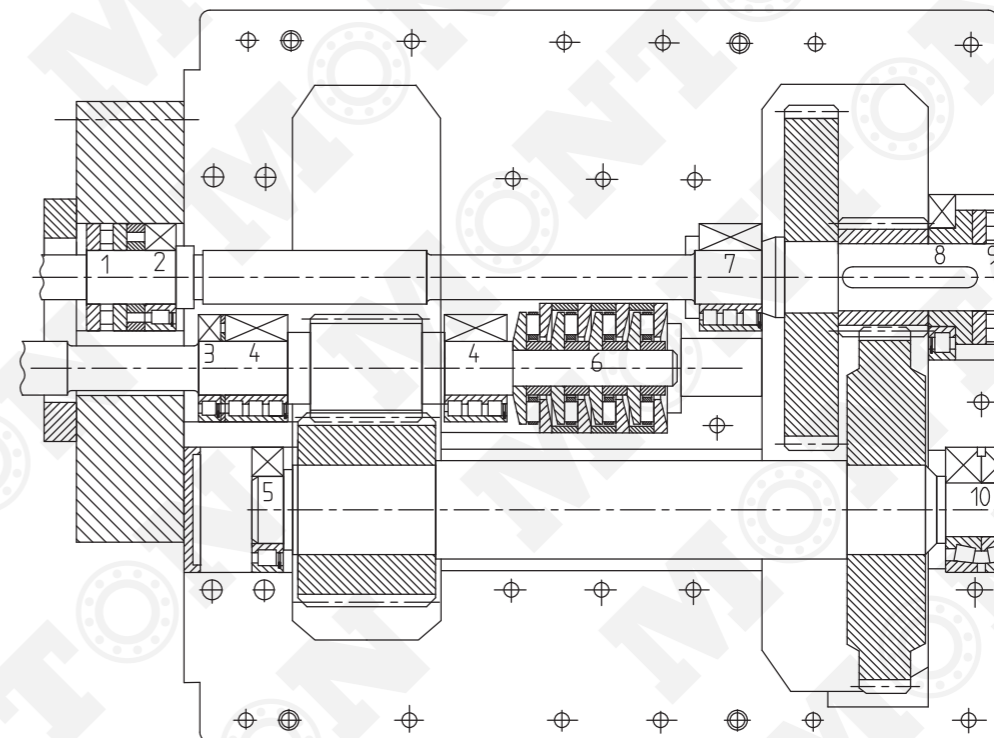

四列推力圆柱滚子轴承的应用示意图
Four row tandem bearing application example

设计 Design

应用领域M.CT系列串联推力轴承专为挤出机齿轮箱开发。轴承主要用于双螺杆挤出机的齿轮箱，但是也用于单螺杆挤出机和三螺杆挤出机的齿轮箱。典型应用领域为：

- ※较小的挤出机，用于饲料和食品行业中的造粒
- ※塑料行业中的挤出机，例如注塑和型材挤出
- ※大型挤出机，用于石化行业生产塑料颗粒

Area of application Tandem axial bearings of series M.CT were developed specifically for extruder gearboxes. The bearings are mainly used in the gearboxes of twin screw extruder, but also of single screw and three screw extruder.

General application :

- ※small extruder for pelletizing in the feed and food industry
- ※extruder in the plastics industry, for example in injection moulding and profile extrusion
- ※large extruder for the production of plastic granulate in the petrochemical industry.

M.CT系列串联推力轴承非常适合用于挤出机，因为它们符合以下要求：

- ※能够承受挤出机螺杆施加在输出轴上的较高背压
- ※需要的径向设计外形尺寸较小。由于工艺原因，这在双螺杆挤出机中会受限于较窄的中心距离
- ※由于充分利用轴向设计外形尺寸，最大限度提高了承载能力
- ※工作寿命长
- ※摩擦力矩较低
- ※异向挤出机的低速运行

Requirements:

Tandem axial bearings of series T.AR are highly suitable for use in extruders as they meet the following requirements:

- ※ Accommodation of high back pressures exerted on the output shafts by the extruder screws
- ※ Small radial design envelope required.
- Due to the process, this is limited by the narrow center distance in twin screw extruders
- ※ Maximum load carrying capacity due to full utilization of the axial design envelope
- ※ Long operating life
- ※ Low frictional torque
- ※ Low speeds of counter-rotating extruders

M.CT系列串联推力轴承是一种在单个方向支撑负载的推力轴承。它由两到八个串联布置的推力圆柱滚子轴承组成，而且中间具有轴承套。这种弹性轴承套系统可将力均匀地分布到各个推力圆柱滚子轴承上。滚动体是产品目录系列中久经考验的圆柱滚子。圆柱滚子由保持架引导。保持架由黄铜、铝或尼龙制成。轴承垫圈和轴承套由淬硬钢制成。对于高性能类型，使用由高性能钢制成的轴承垫圈。

Tandem bearing of series M.CT is an axial bearing for supporting load in one direction. It consists of an assembly of two to eight axial cylindrical roller bearings arranged in line, with sleeves in between. This elastic system of sleeves distributes the force uniformly over the individual axial cylindrical roller bearings. The rolling elements are proven cylindrical rollers from catalogue series. The cylindrical rollers are guided by cages. The cages are made from brass, aluminium or polyamide. Bearing washers and sleeves are made from hardened steel. For the high-performance variant, bearing washers made from high performance steel are used.

负载 Loading

借助轴承套和轴承垫圈的适配几何形状，可以实现每个推力圆柱滚子轴承均匀承受负载。

Uniform loading of each axial cylindrical roller bearing is achieved through the matched geometries of the sleeves and bearing washers.

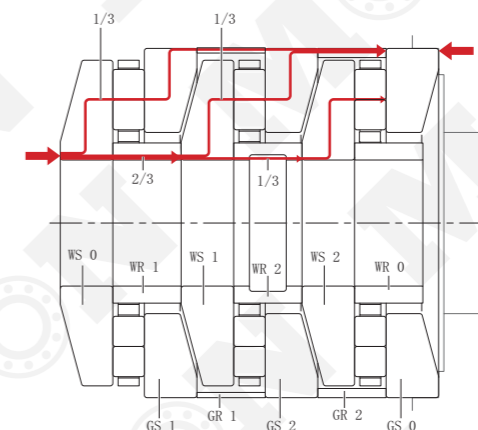

结构和负载流
Structure and power flow

M.CT系列串联推力轴承是一种在单个方向支撑负载的推力轴承。它由两到八个串联布置的推力圆柱滚子轴承组成，而且中间具有轴承套。这种弹性轴承套系统可将力均匀地分布到各个推力圆柱滚子轴承上。滚动体是产品目录系列中久经考验的圆柱滚子。圆柱滚子由保持架引导。保持架由黄铜、铝或尼龙制成。轴承垫圈和轴承套由淬硬钢制成。对于高性能类型，使用由高性能钢制成的轴承垫圈。

A tandem bearing of series M.CT is an axial bearing for supporting load in one direction. It consists of an assembly of two to eight axial cylindrical roller bearings arranged in line, with sleeves inside. This elastic system of sleeves distributes the force uniformly over the individual axial cylindrical roller bearings. The rolling elements are proven cylindrical rollers from catalogue series. The cylindrical rollers are guided by cages. The cages are made from brass, aluminium or polyamide. Bearing washers and sleeves are made from hardened steel. For the high-performance variant, bearing washers made from high performance steel are used.

装配 Mounting

必须按规定的顺序装配各个部件。装配工可在包装中找到相应的装配说明。轴承部件以较高的精度相互匹配，因此在大多数情况下不可互换。如果安装时必须遵守精确的布置，则需要相应地标记相关轴承部件。

The components must be mounted in a defined order. The fitter will find a corresponding mounting instruction in the packaging. The bearing components are matched to each other with a high degree of precision and, as a result, are not interchangeable in most cases. If an exact arrangement must be observed when fitting, the relevant bearing components are marked accordingly.

两列 Two Row

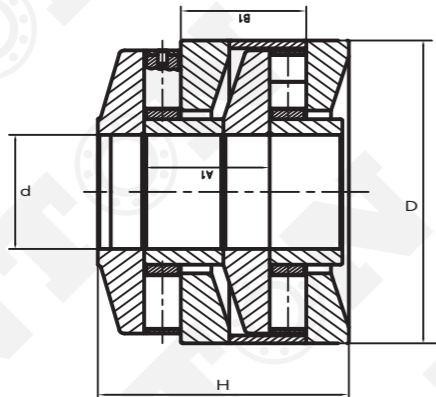

原代号 Old_spec	现代号 Designation	品牌 Brand	基本尺寸 Dimension mm			基本额定负荷 Basic load rating	
			d	D	H	动	静
						dyc_Cr KN	stc_Cor KN
T2AR1242	M2CT1242	MONTON	12	42	41.5	70	157
T2AR3278	M2CT3278	MONTON	32	78	57.5	161	641
T2AR88190Y	M2CT88190Y	MONTON	88.9	190.5	107.95	1359	5534
T2AR89190	M2CT89190	MONTON	88.9	190.5	107.95	1359	5534
T2AR145385	M2CT145385	MONTON	145	385	233	4510	20956
T2AR431863	M2CT431863	MONTON	431.8	863	449.275	17180	88560

表中未列型号与尺寸, 请与我们联系!

If the bearing not list here, please contact with us!

串列推力圆柱滚子轴承由若干个单级推力圆柱滚子轴承, 外隔圈, 内隔圈以及轴组成, 其结构简单紧凑、节省安装空间、安装调试方便、受载均匀、耐磨、振动小、噪音低、寿命长、轴向承载能力大, 已应用在多数双螺杆挤出机齿轮箱中, 成为双螺杆挤出机的核心部件。我司可提供二列, 三列, 四列, 五列, 六列, 七列, 八列, 带轴型和带套筒型串列推力圆柱滚子轴承, 以及根据客户的尺寸要求就行加工设计。客户可根据螺杆中心距、空间大小和负荷大小选择需要的轴承型号。

Tandem Bearings for extruder gearboxes consist of several single row thrust cylindrical roller bearings, outer spacers, inner spacers and shaft. They have simple and compact structures, save installation space, are easy to install and using, they are equal loaded, wear-resistant, and have low vibration, low noise, long life and large axial load capacity. They have been used in most parallel twin screw extruder gearboxes and have become the key components of twin screw extruders. Our company can provide two-row, three-row, four-row, five-row, six-row, seven-row, eight-row, shaft type and sleeve type tandem bearings, we can be processed and designed according to customer size requirements. You can choose the required bearing according to the screw center distance, space size and load rate.

三列 Three Row

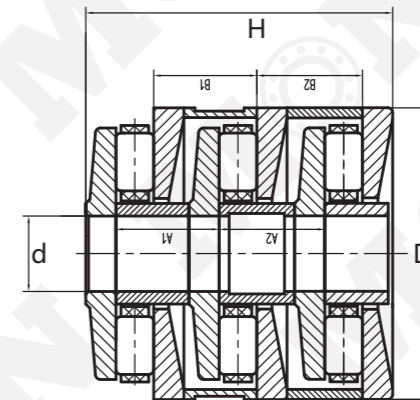

原代号 Old_spec	现代号 Designation	品牌 Brand	基本尺寸 Dimension mm			基本额定负荷 Basic load rating	
			d	D	H	动	静
						dyc_Cr KN	stc_Cor KN
T3AR645	M3CT645	MONTON	6	45	69	136	259
T3AR1242E	M3CT1242E	MONTON	12	42	62.4	120	300
T3AR1949E	M3CT1949E	MONTON	19	49	67	148	425
T3AR2385	M3CT2385	MONTON	23	85	97	320	1545
T3AR2468	M3CT2468	MONTON	24	68	70	161	772
T3AR2468A1a	M3CT2468A1a	MONTON	24	68	70	161	772
T3AR2468A	M3CT2468A	MONTON	24	68	70	161	772
T3AR2468A1	M3CT2468A1	MONTON	24	68	70	161	772
T3AR2866	M3CT2866	MONTON	28	66	82	334	825
T3AR2990	M3CT2990	MONTON	28	90	98	336	1411
T3AR3073	M3CT3073	MONTON	30	73	89	197	267
T3AR3278	M3CT3278	MONTON	32	78	84	290	847
T3AR33105	M3CT33105	MONTON	33	105	115	416	1916
T3AR38150	M3CT38150	MONTON	38	150	163	935	4768
T3AR40110	M3CT40110	MONTON	40	110	123	465	2265
T3AR50160	M3CT50160	MONTON	50	160	167	820	3950
T3AR420900	M3CT420900	MONTON	420	900	768	2900	126000

表中未列型号与尺寸, 请与我们联系!

If the bearing not list here, please contact with us!

四列 Four Row

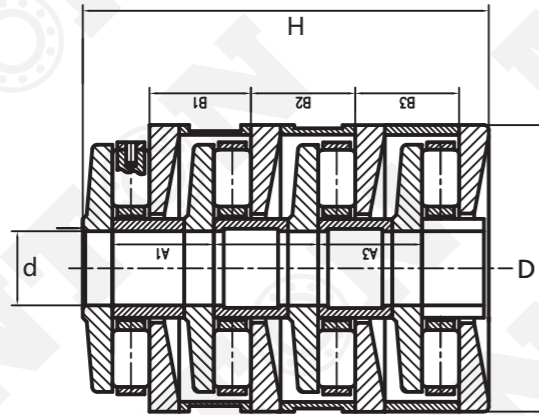

原代号 Old_spec	现代号 Designation	品牌 Brand	基本尺寸 Dimension mm			基本额定负荷 Basic load rating	
			d	D	H	动	静
						dyc_Cr KN	stc_Cor KN
T4AR527	M4CT527	MONTON	5	27	52	40	105
T4AR527E	M4CT527E	MONTON	5	27	52	40	105
T4AR537	M4CT537	MONTON	5	37	78	120	228
T4AR645E	M4CT645E	MONTON	6	45	92	182	466
T4AR1037	M4CT1037	MONTON	10	37	79	84	275
T4AR1037A	M4CT1037A	MONTON	10	37	79	84	275
T4AR1134	M4CT1134	MONTON	11	34	52.5	55	155
T4AR1242	M4CT1242	MONTON	12	42	83.5	108	356
T4AR1860	M4CT1860	MONTON	18	60	101	201	809
T4AR1858	M4CT1858	MONTON	18	58	101	177	728
T4AR1949E	M4CT1949E	MONTON	19	49	88.5	265	669
T4AR2060	M4CT2060	MONTON	20	60	101	201	809
T4AR2047	M4CT2047	MONTON	20	47	79	141	453
T4AR2264	M4CT2264	MONTON	22	64	102.5	201	763
T4AR2264A	M4CT2264A	MONTON	22	64	101	201	763
T4AR2362	M4CT2362	MONTON	23	62	105	202	815
T4AR2362A	M4CT2362A	MONTON	23	62	105	202	815
T4AR2385	M4CT2385	MONTON	23	85	129.5	427	2060
T4AR2598	M4CT2598	MONTON	25	98	150	661	2541

表中未列型号与尺寸，请与我们联系！
If the bearing not list here, please contact with us!

四列 Four Row

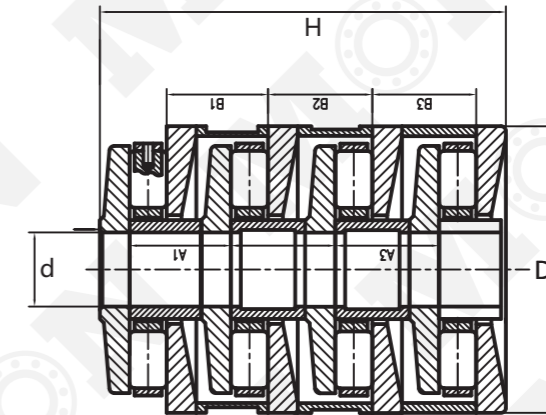

原代号 Old_spec	现代号 Designation	品牌 Brand	基本尺寸 Dimension mm			基本额定负荷 Basic load rating	
			d	D	H	动	静
						dyc_Cr KN	stc_Cor KN
T4AR2866	M4CT2866	MONTON	28	66	107.5	320	1000
T4AR2866A	M4CT2866A	MONTON	28	66	107.5	320	1000
T4AR2264A	M4CT2264A	MONTON	22	64	101	201	763
T4AR3068	M4CT3068	MONTON	30	68	100	230	950
T4AR3073	M4CT3073	MONTON	30	73	122	222	903
T4AR3073E	M4CT3073E	MONTON	30	73	122	244	1030
T4AR3075	M4CT3075	MONTON	30	75	112	304	1045
T4AR30100	M4CT30100	MONTON	30	100	151	499	2371
T4AR3278A	M4CT3278A	MONTON	32	78	110.5	321	1283
T4AR3278	M4CT3278	MONTON	32	78	110.5	321	1283
T4AR33105	M4CT33105	MONTON	33	105	151	521	2555
T4AR3495	M4CT3495	MONTON	34	95	130	377	1900
T4AR3495A	M4CT3495A	MONTON	34	95	145	377	1900
T4AR38150	M4CT38150	MONTON	38	150	214.5	1116	5390
T4AR40127	M4CT40127	MONTON	40	127	177	731	3981
T4AR40110	M4CT40110	MONTON	40	110	164	831	3634
T4AR140360	M4CT140360	MONTON	140	360	424	8400	36200
T4AR350750	M4CT350750	MONTON	350	750	854	27000	118000

表中未列型号与尺寸，请与我们联系！
If the bearing not list here, please contact with us!

五列 Five Row

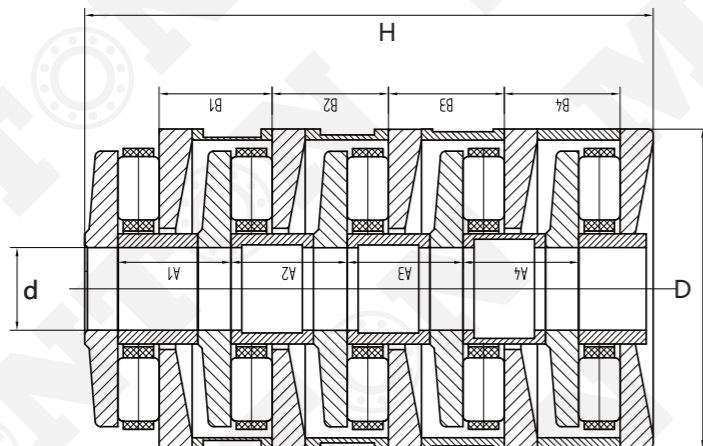

原代号 Old_spec	现代号 Designation	品牌 Brand	基本尺寸 Dimension mm			基本额定负荷 Basic load rating	
			d	D	H	动	静
						dyc_Cr KN	stc_Cor KN
T5AR420	M5CT420	MONTON	4	20	54	31	73
T5AR420A	M5CT420A	MONTON	4	20	54	31	73
T5AR527	M5CT527	MONTON	5	27	65	51	131
T5AR1037EA	M5CT1037EA	MONTON	10	37	99	105	344
T5AR1037E	M5CT1037E	MONTON	10	37	99	105	344
T5AR1242	M5CT1242	MONTON	12	42	104.6	128	445
T5AR1242A	M5CT1242A	MONTON	12	42	104.6	128	445
T5AR1242EA	M5CT1242EA	MONTON	12	42	104.6	129	445
T5AR1242E	M5CT1242E	MONTON	12	42	104.6	129	445
T5AR1858	M5CT1858	MONTON	18	58	126.5	222	910
T5AR1858X2	M5CT1858X2	MONTON	18	58	107.5	311	1120
T5AR2047	M5CT2047	MONTON	20	47	99	177	566
T5AR2262	M5CT2262	MONTON	22	62	110	311	1120
T5AR2262A	M5CT2262A	MONTON	22	62	110	311	1120
T5AR2262A1	M5CT2262A1	MONTON	22	62	110	311	1120
T5AR2264	M5CT2264	MONTON	22	64	128.5	239	954
T5AR2264A	M5CT2264A	MONTON	22	64	128.5	239	954
T5AR2264E	M5CT2264E	MONTON	22	64	128.5	242	1150
T5AR2264EA	M5CT2264EA	MONTON	22	64	128.5	242	1150

表中未列型号与尺寸, 请与我们联系!
If the bearing not list here, please contact with us!

五列 Five Row

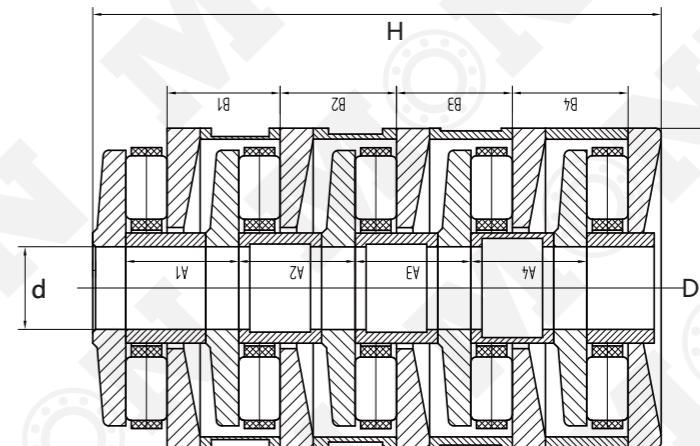

原代号 Old_spec	现代号 Designation	品牌 Brand	基本尺寸 Dimension mm			基本额定负荷 Basic load rating	
			d	D	H	动	静
						dyc_Cr KN	stc_Cor KN
T5AR2385	M5CT2385	MONTON	23	85	162	624	2651
T5AR2362	M5CT2362	MONTON	23	62	131	270	896
T5AR2468A	M5CT2468A	MONTON	24	68	119	336	1415
T5AR2468	M5CT2468	MONTON	24	68	119	336	1415
T5AR2577	M5CT2577	MONTON	25	77	134	403	1753
T5AR2876	M5CT2876	MONTON	28	76	135	392	1664
T5AR2876A	M5CT2876A	MONTON	28	76	135	443	1398
T5AR3073	M5CT3073	MONTON	30	73	153	260	1188
T5AR3073A	M5CT3073A	MONTON	30	73	153	260	1188
T5AR3073E	M5CT3073E	MONTON	30	73	153	289	1286
T5AR3073EA	M5CT3073EA	MONTON	30	73	153	289	1286
T5AR3278	M5CT3278	MONTON	32	78	137	442	1397
T5AR3278A	M5CT3278A	MONTON	32	78	137	391	1664
T5AR3495	M5CT3495	MONTON	34	95	163	583	2495
T5AR36120KK	M5CT36120KK	MONTON	36	120	260	1042	4375
T5AR36120	M5CT36120	MONTON	36	120	197	1042	4375

表中未列型号与尺寸, 请与我们联系!
If the bearing not list here, please contact with us!

六列 Six Row

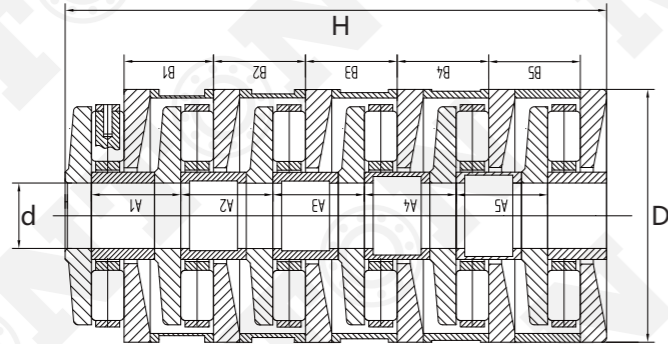

原代号 Old_spec	现代号 Designation	品牌 Brand	基本尺寸 Dimension mm			基本额定负荷 Basic load rating	
			d	D	H	动	静
						dyc_Cr KN	stc_Cor KN
T6AR424	M6CT424	MONTON	4	24	62	56	106
T6AR424X1	M6CT424X1	MONTON	4	24	62	56	106
T6AR424X1A	M6CT424X1A	MONTON	4	24	62	56	106
T6AR420A	M6CT420A	MONTON	4	20	65	35	88
T6AR420	M6CT420	MONTON	4	20	65	35	88
T6AR527	M6CT527	MONTON	5	27	78	56	157
T6AR537	M6CT537	MONTON	5	37	117	165	376
T6AR630	M6CT630	MONTON	6	30	89	66	218
T6AR1242E	M6CT1242E	MONTON	12	42	125.7	154	534
T6AR1452A2E	M6CT1452A2E	MONTON	14	52	151	386	1054
T6AR1872	M6CT1872	MONTON	18	72	172	646	2286
T6AR1872X2	M6CT1872X2	MONTON	18	72	172	646	2286
T6AR2262	M6CT2262	MONTON	22	62	132	357	1450
T6AR2264	M6CT2264	MONTON	22	64	154.5	276	1148
T6AR2264A	M6CT2264A	MONTON	22	64	154.5	276	1148
T6AR2264E	M6CT2264E	MONTON	22	64	154.5	279	1381
T6AR2264A	M6CT2264A	MONTON	22	64	154.5	276	1148

表中未列型号与尺寸，请与我们联系！
If the bearing not list here, please contact with us!

六列 Six Row

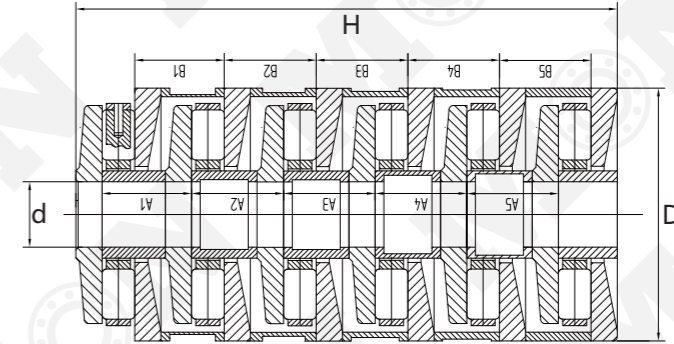

原代号 Old_spec	现代号 Designation	品牌 Brand	基本尺寸 Dimension mm			基本额定负荷 Basic load rating	
			d	D	H	动	静
						dyc_Cr KN	stc_Cor KN
T6AR2270A2	M6CT2270A2	MONTON	22	70	180	513	1500
T6AR2270A2Y	M6CT2270A2Y	MONTON	22	70	182	513	1500
T6AR2390A2	M6CT2390A2	MONTON	23	90	213	828	3238
T6AR2390	M6CT2390	MONTON	23	90	209.75	842	3181
T6AR25105	M6CT25105	MONTON	25	105	234	1072	4574
T6AR2872	M6CT2872	MONTON	28	72	150	434	1730
T6AR2866	M6CT2866	MONTON	28	66	162.5	417	1498
T6AR3073	M6CT3073	MONTON	30	73	182	299	1425
T6AR30127	M6CT30127	MONTON	30	127	288	1145	5970
T6AR30150A	M6CT30150A	MONTON	30	150	335	2205	9250
T6AR30145	M6CT30145	MONTON	30	145	335	2070	9375
T6AR3278	M6CT3278	MONTON	32	78	163.5	497	1616
T6AR3495	M6CT3495	MONTON	34	95	196	699	2994
T6AR38160	M6CT38160	MONTON	38	160	360	1622	8875
T6AR38160A2	M6CT38160A2	MONTON	38	160	340	1729	8019
T6AR43158A2	M6CT43158A2	MONTON	43.18	158.75	278.765	2116	8775
T6AR85290	M6CT85290	MONTON	85	290	580	6200	26000

表中未列型号与尺寸，请与我们联系！
If the bearing not list here, please contact with us!

七列 Seven Row

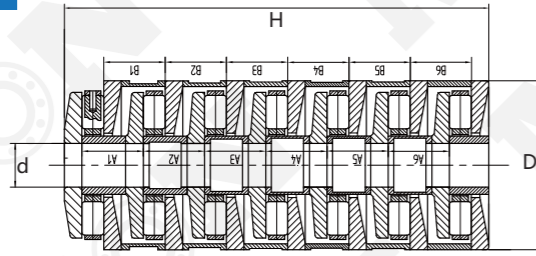

原代号 Old_spec	现代号 Designation	品牌 Brand	基本尺寸 Dimension mm			基本额定负荷 Basic load rating	
			d	D	H	动	静
						dyc_Cr KN	stc_Cor KN
T7AR1880	M7CT1880	MONTON	18	80	200	690	2771
T7AR18100	M7CT18100	MONTON	18	100	266	1351	5733
T7AR18100A	M7CT18100A	MONTON	18	100	306	1351	5733
T7AR2264	M7CT2264	MONTON	22	64	180	362	1471
T7AR2385A	M7CT2385A	MONTON	23	85	227	860	4020
T7AR25105	M7CT25105	MONTON	25	105	273	1265	5821
T7AR25120A	M7CT25120A	MONTON	25	120	336	1668	7250
T7AR30135A	M7CT30135A	MONTON	30	135	339	2036	9605

八列 Eight row

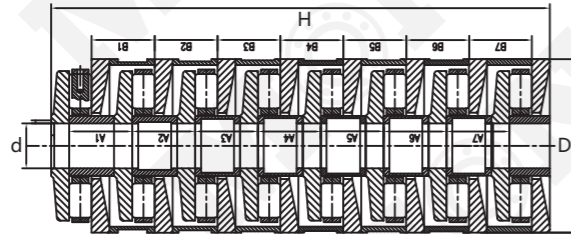

原代号 Old_spec	现代号 Designation	品牌 Brand	基本尺寸 Dimension mm			基本额定负荷 Basic load rating	
			d	D	H	动	静
						dyc_Cr KN	stc_Cor KN
T8AR645	M8CT645	MONTON	6	45	183.5	292	693
T8AR18100	M8CT18100	MONTON	18	100	304	1351	5733
T8AR2270A2E	M8CT2270A2E	MONTON	22	70	233	572	2245
T8AR25105A2	M8CT25105A2	MONTON	25	105	320	1208	5223
T8AR2552	M8CT2552	MONTON	25	52	165	244	938
T8AR2890	M8CT2890	MONTON	28	90	281	914	3604
T8AR30127	M8CT30127	MONTON	30	127	372	1488	8435
T8AR3495	M8CT3495	MONTON	34	95	262	874	3991
T8AR2552YA	M8CT2552YA	MONTON	25	52	167	244	938
T8AR1860E	M8CT1860E	MONTON	18	60	202.5	914	3604
T8AR2552	M8CT2552	MONTON	25	52	165	244	938
T8AR120360	M8CT120360	MONTON	120	360	900.5	12100	62400
T8AR120465	M8CT120465	MONTON	120	465	985	14400	65600

表中未列型号与尺寸，请与我们联系！
If the bearing not list here, please contact with us!

带轴型 Shaft type

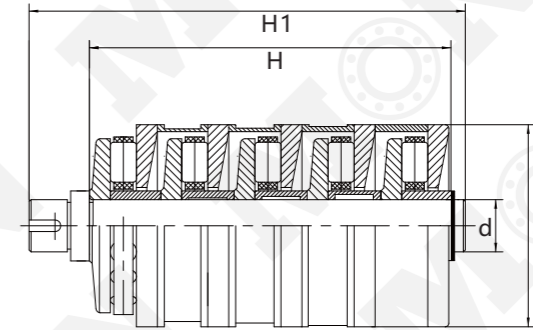

原代号 Old_spec	现代号 Designation	品牌 Brand	基本尺寸 Dimension mm			基本额定负荷 Basic load rating		重量 Weight/ kg
			d	D	H	动	静	
						dyc_Cr KN	stc_Cor KN	
T3AR2468A1a	M3CT2468A1a	MONTON	24	68	70	161	772	2.38
T3AR2468A	M3CT2468A	MONTON	24	68	70	161	772	1.75
T3AR2468A1	M3CT2468A1	MONTON	24	68	70	161	772	2.31
T4AR1037A	M4CT1037A	MONTON	10	37	79	84	275	0.55
T4AR2264A	M4CT2264A	MONTON	22	64	101	201	763	2.11
T4AR2362A	M4CT2362A	MONTON	23	62	105	202	815	2.14
T4AR2866A	M4CT2866A	MONTON	28	66	107.5	320	1000	2.37
T4AR2264A	M4CT2264A	MONTON	22	64	101	201	763	2.11
T4AR3278A	M4CT3278A	MONTON	32	78	110.5	321	1283	3.83
T4AR3495A	M4CT3495A	MONTON	34	95	145	377	1900	6.15
T5AR420A	M5CT420A	MONTON	4	20	54	31	73	0.093
T5AR1037EA	M5CT1037EA	MONTON	10	37	99	105	344	0.57
T5AR1242A	M5CT1242A	MONTON	12	42	104.6	128	445	0.925
T5AR1242EA	M5CT1242EA	MONTON	12	42	104.6	129	445	0.9
T5AR2262A	M5CT2262A	MONTON	22	62	110	311	1120	2.2
T5AR2262A1	M5CT2262A1	MONTON	22	62	110	311	1120	2.2
T5AR2264A	M5CT2264A	MONTON	22	64	128.5	239	954	2.55
T5AR2264EA	M5CT2264EA	MONTON	22	64	128.5	242	1150	2.425
T5AR2468A	M5CT2468A	MONTON	24	68	119	336	1415	2.92
T5AR2876A	M5CT2876A	MONTON	28	76	135	443	1398	4.73
T5AR3073A	M5CT3073A	MONTON	30	73	153	260	1188	4.1
T5AR3073EA	M5CT3073EA	MONTON	30	73	153	289	1286	3.877
T5AR3278A	M5CT3278A	MONTON	32	78	137	391	1664	4.22
T6AR424X1A	M6CT424X1A	MONTON	4	24	62	56	106	0.168
T6AR420A	M6CT420A	MONTON	4	20	65	35	88	0.115
T6AR2264A	M6CT2264A	MONTON	22	64	154.5	276	1148	3.52
T6AR2264A	M6CT2264A	MONTON	22	64	154.5	276	1148	3.52
T6AR30150A	M6CT30150A	MONTON	30	150	335	2205	9250	39.4
T7AR18100A	M7CT18100A	MONTON	18	100	306	1351	5733	7.44
T7AR2385A	M7CT2385A	MONTON	23	85	227	860	4020	8.11
T7AR25120A	M7CT25120A	MONTON	25	120	336	1668	7250	21.4
T7AR30135A	M7CT30135A	MONTON	30	135	339	2036	9605	30.7

表中未列型号与尺寸，请与我们联系！
If the bearing not list here, please contact with us!

套筒型 Sleeve type

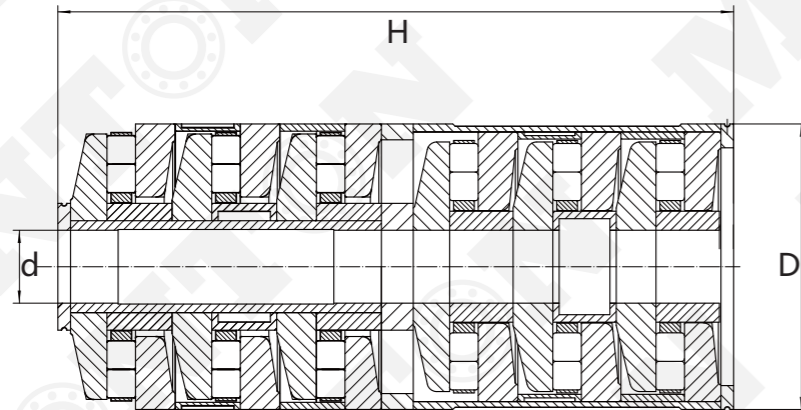

其他型号 Other codes

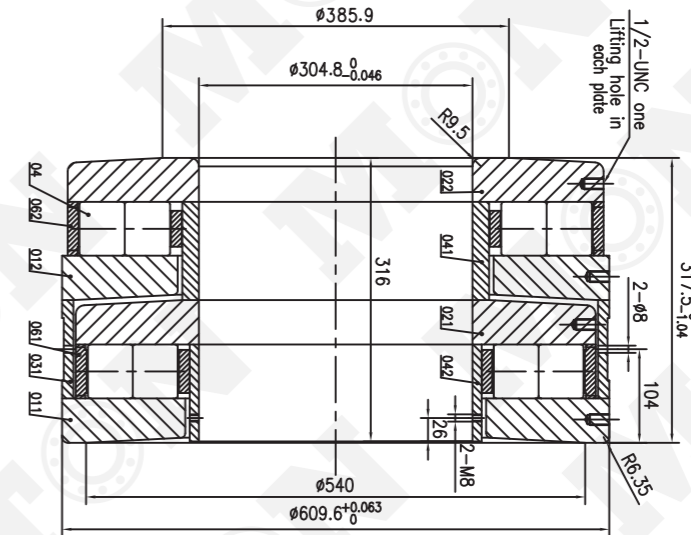

原代号 Old_spec	现代号 Designation	品牌 Brand	基本尺寸 Dimension mm			基本额定负荷 Basic load rating		重量 Weight/ kg
			d	D	H	动	静	
						dyc_Cr KN	stc_Cor KN	
T6AR1452A2E	M6CT1452A2E	MONTON	14	52	151	386	1054	1.51
T6AR2270A2	M6CT2270A2	MONTON	22	70	180	513	1500	2.874
T6AR2270A2Y	M6CT2270A2Y	MONTON	22	70	182	513	1500	2.874
T6AR2390A2	M6CT2390A2	MONTON	23	90	213	828	3238	7.42
T6AR38160A2	M6CT38160A2	MONTON	38	160	340	1729	8019	40.8
T6AR43158A2	M6CT43158A2	MONTON	43.18	158.75	278.765	2116	8775	33
T8AR2270A2E	M8CT2270A2E	MONTON	22	70	233	572	2245	4.4
T8AR25105A2	M8CT25105A2	MONTON	25	105	320	1208	5223	17.3
T8AR30127A2	M8CT30127A2	MONTON	30	127	372	1488	8435	30.97

型号 Designations	型号 Designations	型号 Designations	型号 Designations
TAB-040082-201	TAC-014035-202	F-55471-100.T2AR	F-215427.T8AR
TAB-040100	TAC-022094-201	F-55471.T2AR	F-81600.T8AR
TAB-050090-202	TAC-030053-210	F-81682.T4AR	F-80134.T8AR
TAB-060110-280	TAC-030066-204	F-53043.T6AR	F-213621.T6AR
TAB-060120-201	TAC-040100-202	F-53043-100.T6AR	F-50988.T4AR
TAB-060140-201	TAC-101215-203	F-84897-100.T6AR	F-214794.T4AR
TAB-062120-201	TAC-120240-207	F-84897.T6AR	F-59224.T4AR
TAB-070140-204	TAC-170340-204	F-52548.T6AR	F-208004.T6AR
TAB-070140-205	TAD-012033-204	F-52548-100.T6AR	F-86698.T4AR
TAB-070160-201	TMD-040127	F-52541.T3AR	F-81395.T3AR
TAB-072160-202	TAD-017047-202	F-87920-100.T8AR	F-234700.T8AR
TAB-080160-201	TAD-030082	F-87920.T8AR	F-50952.T3AR
TAB-080172-201	TAD-059120-201	F-51909.T3AR	F-212505.T4AR
TAB-090190-202	TMF-023090	F-81658-100.T8AR	F-205274.T8AR
TAB-092169-203	TAF-011028	F-81658.T8AR	F-81395.T3AR
TAB-100180	TMF-030127-201	F-53042.T6AR	F-96517.T2AR
TAB-100200-202	TAF-017063	F-81684.T4AR	F-43998.T3AR
TAB-100200-204	TAF-019060	F-58771.T4AR	F-85176.T3AR
TAB-101215-204	TMH-023090-201	F-81660.T8AR	F-213625.T6AR
TAB-120240-209	TMH-023092	F-86722.T4AR	F-96709.T2AR
TAB-140260-201	TMH-030127	F-52530.T6AR	F-83053.T2AR
TAB-140280-201	TMH-040170	F-81616.T5AR	F-213271.T3AR
TAB-170340-201	F-211952.T4AR	F-53579.T3AR	F-82713.T4AR
TAB-220420-201	F-81657-100.T8AR	F-52523.T6AR	F-43964.T4AR
F-81657.T8AR	F-81683.T4AR	F-52523-100.T6AR	F-81661.T8AR
F-230605.T4AR	F-59413.T4AR	F-53507-100.T6AR	F-83368.T4AR
F-53507.T6AR	F-52978.T4AR	其他常见型号, Other bearing codes.	

表中未列型号与尺寸, 请与我们联系!
If the bearing not list here, please contact with us!

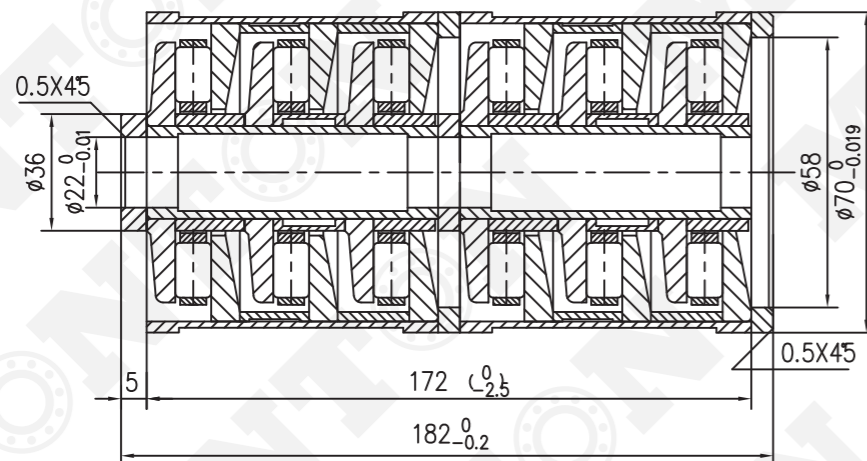

F-53507.T6AR 全套筒型串联轴承
F-53507.T6AR Full sleeve type tandem bearing

表中未列型号与尺寸, 请与我们联系!
If the bearing not list here, please contact with us!

其他型号 Other codes

盟拓轴承可接受各类非标定制尺寸的串列推力圆柱滚子轴承，按客户来图加工，或者按客户要求设计加工。当前我司已经为来自全球各地挤出机用户提供了超过500种不太尺寸的定制轴承。受到客户与市场的欢迎，也为国内外大扭矩齿轮箱行业提供优质的串列推力圆柱滚子轴承。

MONTON Bearing can accept various non-standard and customized sizes of tandem bearings, produce according to customer drawings or according to customer requirements. We have provided over 500 customized tandem bearings in various sizes for extruder users all over the world. Highly welcomed by customers and the market, we also provide high-quality tandem bearings for the high torque gearbox industry both domestically and internationally.

轴承型号 BEARING NO.	尺寸Dimensions(mm)			列数 Rows
	内径 ID	外径 OD	高度 H	
TAB-035075M	88.9	187.9	108	2
ST16050413/C.100.038	50	160	412	8
M6CT60142	60	142	255	4
M7CT2390	23	90	244.75	7
M4CT105255	105	255	325	4
86TI893	18	93	258	6
TS-90M6CT2390	23	90	199.5	6
M6CT2270	22	70	141	6
TAB-030053-20	3	5.388	2.84	2
T6AR1555	15	55	185	6
M8CT2390	23	90	390	8
M5CT950	9	50	120	5
M8CT94200	94	200	548	8
M6CT20127	20	127	265.68	6
TAB-140280-201M	355.6	711.2	336.55	2
TAC-120240-207M	304.8	609.6	539.75	3
A-ARX60X320X756PX1	60	320	756	8
04-17065-A	60	270	855	8
M8CT60320960	60	320	960	8
T2AR 350x750x440	350	750	440	4
TAC-30.15x114.3x117.63 M	30.15	114.3	117.63	
TAC 22.225x88.9x91.92M	22.225	88.9	91.92	
TAC 30.15 x 114.3 x 88.92 M	30.15	114.3	88.92	
M2CT420900519	420	900	519	2
M6CT1565 181.0527	15	65	130	6
KB8-45180	45	180	480	8
A-ARX60X320X756PX1	60	320	756	
A-ARX70X320X960-1PX1	70	320	960	
A-ARX60X270X8551PX1	60	270	855	

表中未列型号与尺寸，请与我们联系！
If the bearing not list here, please contact with us!

图片 Picture

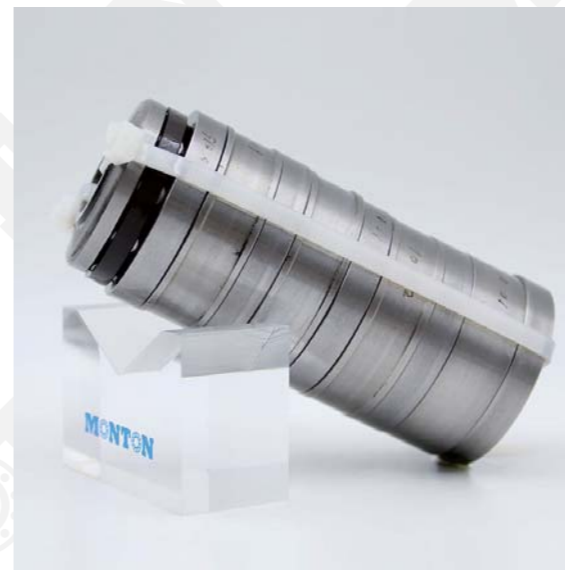

常规挤出机轴承
General Tandem Bearing



带轴型挤出机轴承
Shaft Type Tandem Bearing



套筒型挤出机轴承
Sleeve Type Tandem Bearing



洛阳盟拓轴承科技有限公司

Luoyang MONTON Bearing Science & Technology Co.,Ltd.

检测报告 Test Report

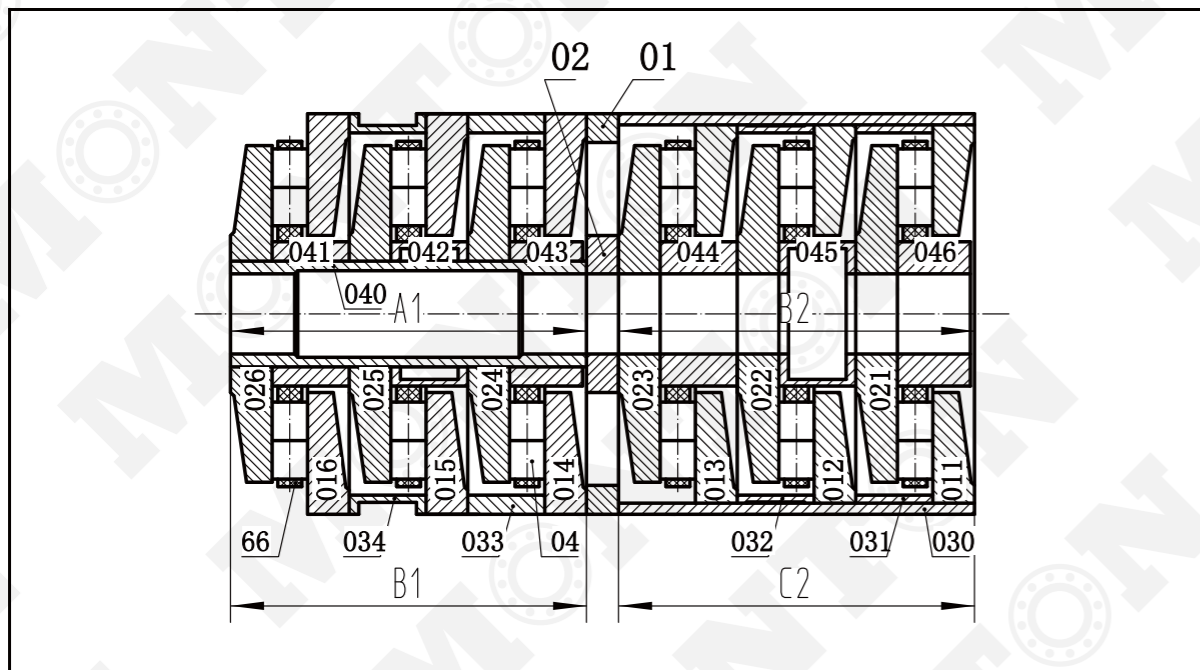

报告内容 Report details

型号 Model :

F-53043.T6AR

d: 23 mm D: 90 mm H: 209.75 mm

A1-B1: mm

B2-C2: mm

合格 Qualified

注意事项 Cautions:

- Bearing should be installed and disassembled by professional tools with uniform force. It is forbidden to strike and beat bearings. If interference is too big, bearings should be heated in mineral oil from 90 Celsius degree to 100 Celsius degree for installation.
- Shaft and housing tolerance should be matched with bearings tolerance. 3. Bearings should be stored in clean, ventilated and Non-corrosive gas place, humidity not more than 65%. Regular antirust measure should be taken for long-period store.
- Before send the bearing to customer , the bearing has been inspected and assembled in good condition. Please installation by order number marked on the bearing. If disordered install, maybe cannot install perfectly, please send back the photo with mark number on bearing surface and contact with us, We will guide for you.
- 轴承安装拆卸应使用专用工具，受力均匀，严禁敲打。如配合过盈较大，则应把轴承放入矿物油内加热到90°C-100°C后立即装上并涂油。
- 轴与壳体精度应与轴承制造精度相匹配。
- 轴承存放处应清洁通风，无腐蚀气体，相对湿度不超过65%。长期保管应定期防锈。
- 轴承出厂前，已经过检查和组装，状况良好。请按轴承上标明的订货号进行安装。如果安装不当，可能无法完美安装，请将带标记 号的照片发回厂家并与我们联系，我们将为您提供指导。

带轴型串联推力圆柱滚子轴承由若干个单级推力圆柱滚子轴承，外隔圈，内隔圈以及轴组成。通过设置在每个推力圆柱滚子轴承的内外隔圈串联在轴上，并用弹簧卡圈锁紧，形成带轴型串联推力圆柱滚子轴承。带轴型串联推力圆柱滚子轴承为不可拆卸型轴承单元，安装使用方便，减轻装配繁琐度，保证轴承装配精度以及承载性能，提高轴承使用寿命。我们可以根据客户需要为客户提供轴的设计与加工。

A tandem Bearing with shaft consist of several single thrust roller bearing, outer spacer, inner spacer and shaft. Arrange the bearing in one shaft and locking by spring retainer, then become a tandem bearing with shaft. Tandem bearing with shaft is a non-removable bearing unit, easy install , reduce the assembly work , Ensure the assembly accuracy and load-bearing performance of the bearings, Increase the service life of bearings. We can supply shaft according to customers application.

轴					M4CT3278A.059		
					图样标记	重量	比例
					样试		---
					共 2 页	第 2 页	
					MONTON		

标记	处数	更改文件号	签字	日期
设计				
校对				
审核				
批准				日期

公司证书 Certificate

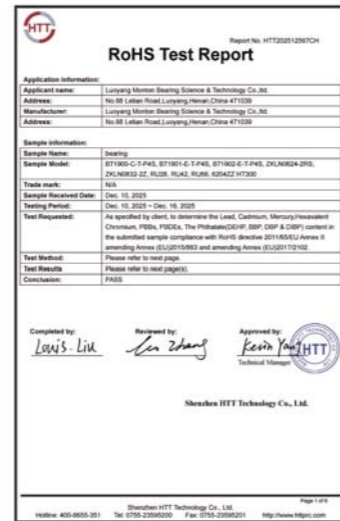
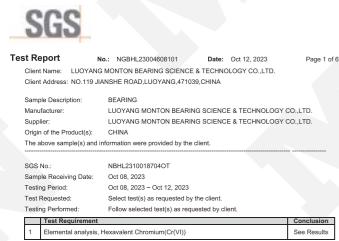

检测设备 Test equipment



ACCRETECH From Japan Coordinate Measuring Machines
ACCRETECH 日本三坐标测量仪



Talyrond Roundness Measurement System
英国泰勒圆度仪



RONDCOM NEX roundness system
RONDCOM圆度测量仪



Mitutoyo roughness measurements
日本三丰粗糙度测量仪



SURFCOM INEX Texture Contour Measuring Instrument
SURFCOM表面纹理和轮廓测量仪



Digital Universal Length Measurer
万能测长仪



SBV-1 steel ball vibration measuring instrument
SBV-1型钢球振动测量仪



BVT-1A bearing vibration measuring instrument
BVT-1A轴承振动测量仪



Bearing life testing machine
轴承寿命强化试验机



Bearing heat treatment furnace
轴承热处理设备



Liquid nitrogen cryogenic cabinet
轴承液氮深冷处理箱